

GENERAL MOTORS

Volume 13 - - - Number 1

First Quarter, 1966

ENGINEERING JOURNAL

for educators
in the fields of engineering
and allied sciences



Toromado

The Automotive Challenge

FOR many people, the automobile provides convenient, comfortable, safe, and almost indispensable personal mobility. Most people, however, take for granted the availability of the automobile and the complex developments that have made it safe, dependable, and relatively simple to operate.

Engineers probably have better insight into the amount of hard work required to produce an automobile, but even engineers associated with the industry sometimes find it difficult to comprehend the vast interplay of activities encompassed in the development of a new car.

The First and Second Quarter 1966 issues of the *General Motors Engineering Journal* are intended to tell the engineering story of the conception, development, and production of a new automobile. Each new model developed by General Motors has a similar, although not identical, history. The end result is the product of many hours of effort on behalf of the car Division, body and accessory Divisions, GM Technical Center Staffs, and other GM units. Working together within the GM framework of decentralized operations, these nearly autonomous units function as a team, with the car Division having ultimate responsibility for the car's design, development, and production.

To serve as an example of how a new car model is produced, we have selected the 1966 Toronado by Oldsmobile Division. Since this car is unique among other

new American vehicles, it serves as an excellent medium for describing how a new car comes into being.

Educators who have visited General Motors have commented frequently about the great variety of engineering associated with the automotive industry. The design and development of a product as complex as the automobile requires many diverse engineering assignments, ranging from combustion studies and materials development to electronics and lubrication studies, and from such basic research as studies of magnetism and friction to the practical application of production methods and process development. These varied tasks require the talents of literally all kinds of engineers and physical scientists.

The results of these efforts must be coordinated into component and sub-assembly designs, such as transmissions, engines, bodies, suspensions, brake and electrical systems, instruments, and steering assemblies. These items must be designed to merge smoothly into the final product—the automobile, which not only must perform well, be safe, durable, reliable, and economical to manufacture, but also must have style and strong appeal to the consumer. It is easy to see why the overall task of producing a new car requires not months but years to perform.

While the effort to develop a new car requires the coordination of many diverse engineering talents into a smoothly func-



tioning team, there are many opportunities for individual effort and performance. Literally thousands of challenges face the engineers who contribute toward the development of a new car. These challenges range from designing entirely new components or production techniques to refining existing devices, components, and methods.

Through continuous product improvement and refinement the value of the automobile has increased while costs have been held stable or reduced. The innovations provided by the engineer in improving reliability and performance while contributing to the reduction of production costs have been important to the growth of the economy by offsetting increases in other factors affecting price.

The development of a new automobile is truly an American success story. General Motors is justly proud of its contributions toward economic progress, and proud of the quality performance record of its engineers.

A handwritten signature in black ink that reads "J. M. Roche".

J. M. Roche,
President

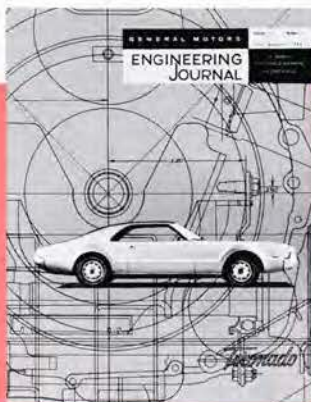

THE COVER

The development of a new automobile, such as the Toronado by Oldsmobile, is a cooperative project. From its initial phases, the design of a new car involves the simultaneous efforts of many engineers, designers, and technicians to produce a vehicle that provides the best in engineering, safety, and styling. The work of the engineer and designer is depicted in this issue's cover design showing a profile of the front wheel drive Toronado against a back-

ground of a typical engineering drawing prepared during its development. These two elements symbolize the joint efforts of engineers and designers at Oldsmobile, the GM Styling and Engineering Staffs, Fisher Body Division, and other GM units who contributed to the successful development of the Toronado. The cover design was developed by the Graphics Design Studio of the General Motors Styling Staff.

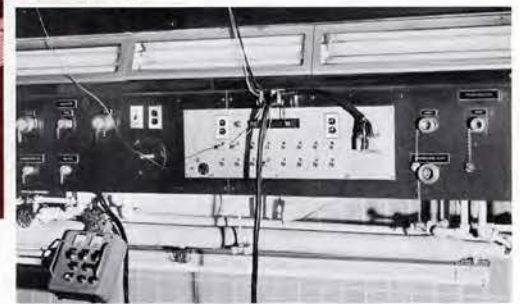
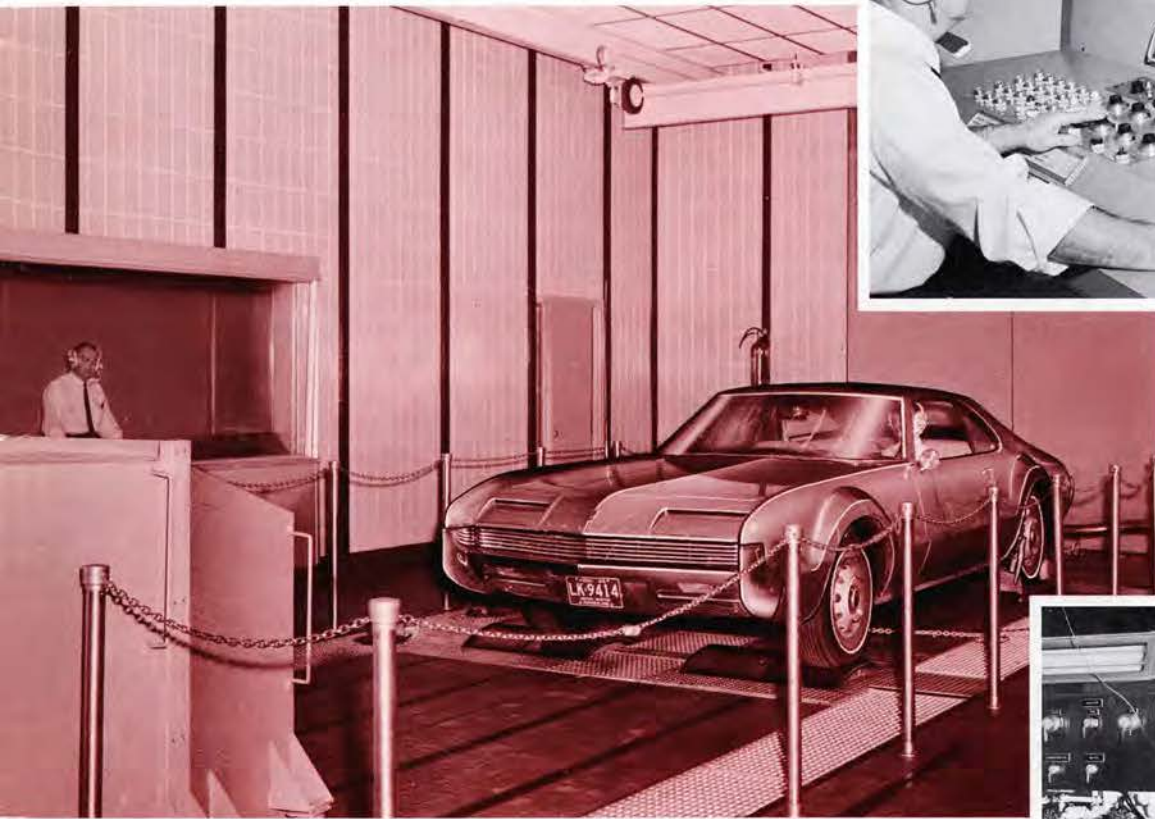

ENGINEERING TESTING

During the development of the front axle for the 1966 Toronado, Saginaw Steering Gear Division engineers conducted many hours of durability, fatigue, and performance testing. In addition, extensive test programs were run on Saginaw's chassis dynamometer to aid in the development of the inboard and outboard universal joints, the steering linkage, and the power steering pump and gear for the Toronado.

Saginaw's dynamometer is designed to accommodate a variety of vehicle configurations, including front wheel drive vehicles. This capability is provided by having the rolls placed between two identical service pits, each equipped with elevator platforms, complete instrumentation, and accessories. The large photograph shows an Oldsmobile Toronado on the dynamometer. The elevators are in the raised position.

The dynamometer rolls can duplicate vehicle speeds in excess of 120 mph at a constant absorption rate of 300 hp. Simulation of vehicle inertia, frontal wind resistance, and grades encountered during driving is accomplished using electronic control circuitry. The dynamometer is controlled from a console room adjacent to the test area (top inset). In addition, a small portable station with flexible cable connection to the console room permits control from inside the vehicle during testing.

Each stainless steel roll provides 17 in. of smooth and 17 in. of

bump surface. A mechanical coupling between the roll shafts permits easy disengagement for individual or tandem roll operation. Differential speeds between rolls can be varied up to 20 per cent, which provides simulation of cornering effects. The coupling also allows much flexibility in adjusting phase relationships between roll bumps.

Additional dynamometer facilities include: an airfoil type centrifugal cooling fan that can provide air at 132,000 cfm from zero to 120 mph; an air temperature control system that controls fan air temperature from a minimum of 40 F to a maximum of 120 F at maximum velocity; an underbody cooling system that provides additional spot cooling during low-speed, high-torque testing to such components as differentials, shock absorbers, and mufflers; and transmission oil and engine water cooling systems that can maintain transmission and engine temperatures at constant values through external heat exchangers.

Each dynamometer service pit contains identical stainless steel patch panels built into the walls (lower inset). These panels contain plugboard connections for test vehicle instrumentation, two-way speakers for communication with the console room, and connections for the underbody cooling, exhaust, transmission oil cooling, and engine cooling systems.

The chassis dynamometer at Saginaw Steering Gear Division is a composite test facility possessing many diversified functions and capabilities. As a dynamometer it is used primarily in driveline evaluations. In front end and steering system studies, it acts as a bump rig imposing severe shock loads on the linkage and suspension components. The dynamometer played an important role in the development of the Toronado front axle universal joint designed by Saginaw engineers.

An Overall Look at the Toronado—A New Breed of Automobile

By JOHN B. BELTZ
Oldsmobile
Division

Front wheel drive
provided unique
engineering challenges



THE Toronado was born of a desire to create a better automobile, one with more usable room and improved roadability. The project was initiated because of the conviction that a continuing policy of offering something better in automotive transportation is essential to Oldsmobile's success. This was a big step forward and meant approaching the design unfettered by commitment to traditional arrangement.

The use of a front wheel drive system, in which all power and driving components are combined into a single unit ahead of the passenger compartment, proved to be an important element in attaining that improved vehicle. As a result, the Toronado represents a new breed of contemporary automobile.

The indicated advantages for the unitized power package approach to car design are primarily in space utility, drive traction, directional stability, and handling. These benefits were worth going after and the engineering challenge was

welcomed. Their final realization in the Toronado represents thousands of creative manhours, one and a half million test miles, and over seven years of work. The car culminates a combined effort by engineers not only at Oldsmobile, but also at the General Motors Technical Center Staff activities and allied Divi-

sions in the areas of design, styling, testing, development, and manufacturing.

Design Includes Many Innovations

The exterior size of the Toronado is less than that of the regular line of Oldsmobile cars because interior space is used

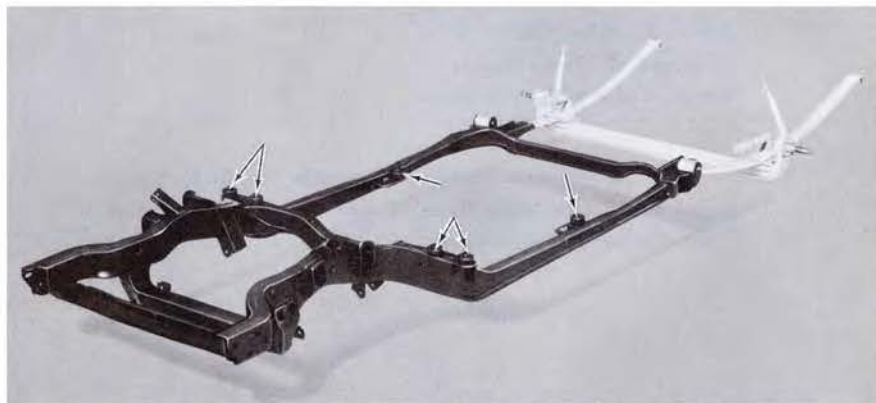

Fig. 1—TORONADO FRAME WITH BODY MOUNTS AND REAR SUSPENSION. The Toronado frame arrangement permits drive and suspension components to be isolated from the body by rubber mounts (indicated by the arrows), while providing integral construction at the rear of the car.

more efficiently by elimination of the floor tunnels and the kick-up over the rear axle. A review of the major components and their arrangement in the car discloses many areas of outstanding achievement in design.

Chassis

Beginning with the chassis, the frame of the car ends behind the forward mounting of the rear spring (Fig. 1). This arrangement permits isolation of the drive and suspension components from the body with rubber body mounts on the separate frame, while at the same time using integral construction at the rear of the car where space is at a premium.

Single-leaf springs and a stamped axle assembly are used in the rear suspension (Fig. 2), which is mounted through rubber at the spring eyes. Four rear shock absorbers are used, two vertical, two horizontal. Front suspension is a torsion bar design (Fig. 3). The torsion bars work from the lower control arms and are anchored in a cross bar which is isolated from the frame through rubber. One set of torsion bars covers all car weights by the provision of a carrying height adjustment at the anchor end.

A dual outlet exhaust system is used with the muffler located crosswise, ahead of the fuel tank and behind the rear axle (Fig. 4). The flat, horizontal fuel tank with rear fill is located beneath the trunk floor.

Overall steering ratio is 17.8 to 1. This compares to 21.7 to 1 for the regular full-size Oldsmobile. The steering column assembly (Fig. 4) uses an added universal joint to provide a comfortable column angle (Fig. 5).

Drive shafts on each side of the car transmit torque to the front wheels through two constant velocity universal joints on each shaft. The right hand shaft assembly includes a rubber damper which cushions peak forces for maximum drive smoothness. The inboard universal joint takes in and out travel as well as rotational and angular movements. This is accomplished by an additional ball race which permits the entire joint assembly to move laterally as the suspension swings (Fig. 6).

During the early development of the car, a number of brake systems were evaluated, including inboard and out-board mounted disc designs, with the objective of attaining the best brakes for the car's requirements. The best overall

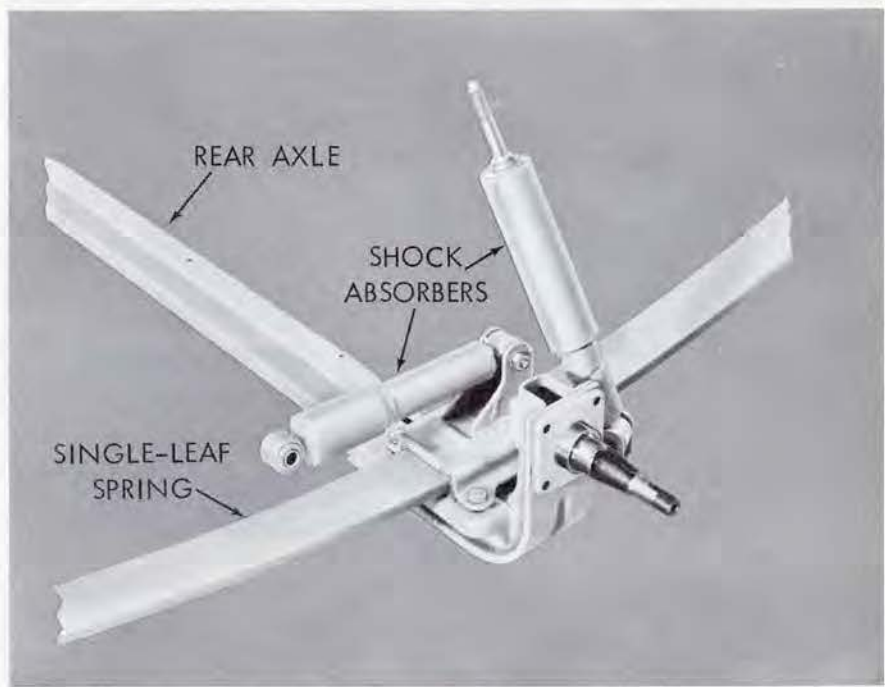
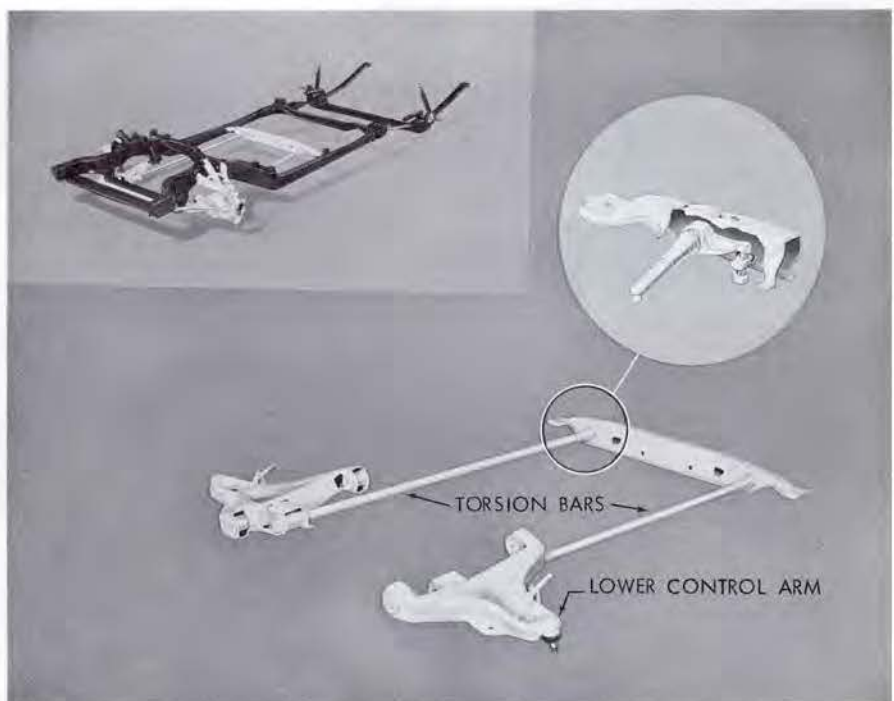

Fig. 2—REAR SUSPENSION. The relationship of the single-leaf spring to the stamped rear axle assembly is shown by this closeup view of the rear suspension. Also shown are the two shock absorbers—one vertical, one horizontal—which are duplicated at the other rear wheel.



Fig. 3—TORSION BAR SYSTEM. The front suspension of the Toronado consists of torsion bars extending from the lower control arms to the cross bar anchor. A height adjustment (inset) permits one set of bars to cover all car weights.



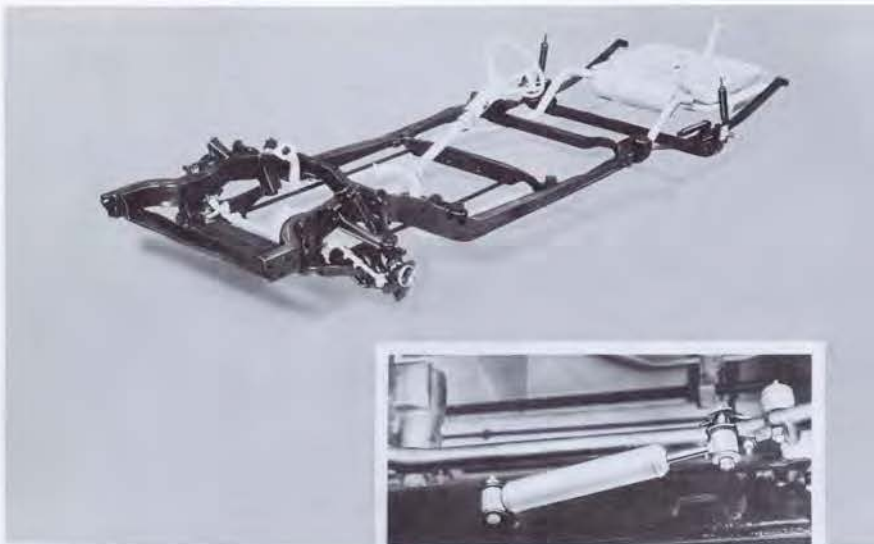

Fig. 4—STEERING SYSTEM. The Toronado steering system includes a special shock absorbing connection between the steering linkage and frame (inset). The photo also indicates the exhaust system arrangement.

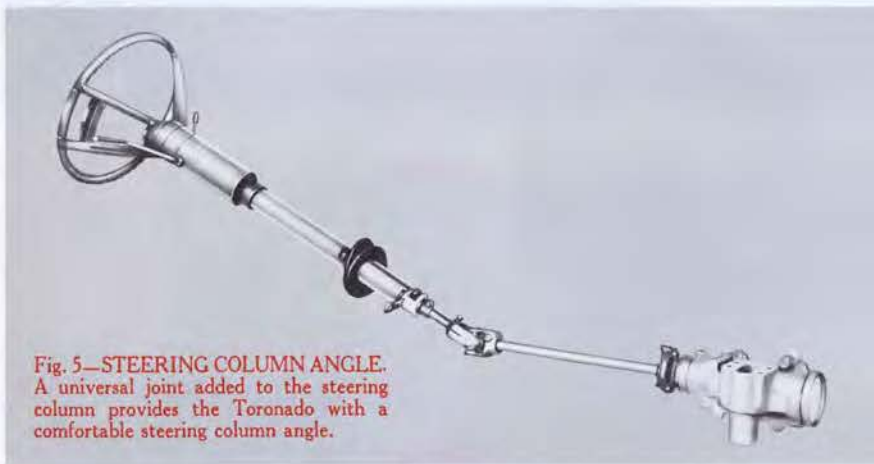
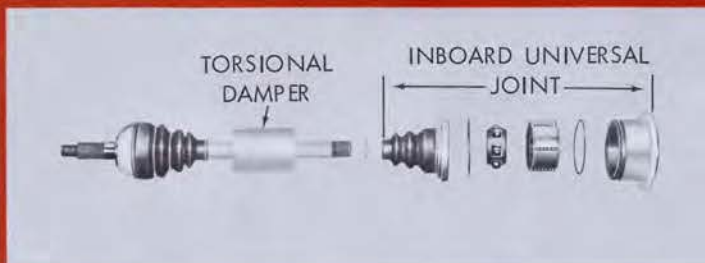

Fig. 5—STEERING COLUMN ANGLE. A universal joint added to the steering column provides the Toronado with a comfortable steering column angle.



Fig. 6—DRIVE SHAFT INBOARD UNIVERSAL JOINT. The Toronado uses two drive shafts to transmit power to the front wheels. Each drive shaft contains two constant velocity universal joints, with the inboard joint (exploded view) designed to accommodate lateral as well as rotational and angular movements. This is accomplished through an additional ball race. A rubber damper is included in the right drive shaft to provide maximum drive smoothness.



combination developed was an improved drum type. Cast finned brake drums are used which are cooled through openings in the wheel spider (Fig. 7). The wheel spider and drum are offset into the air stream, and wheel openings are designed for adequate air flow over the drum fins. This design has resulted in reduced brake temperatures, giving good fade characteristics and stability.

Since both driving torque and steering are transmitted through the front wheels, care was taken to select a tire that suited the car's needs. Particular attention was paid to tire structure in tuning for good handling and tread pattern for exceptional traction. The car uses an 8.85 × 15 T-FD (Toronado-Front Drive) tire. Tire life with the recommended 6,000-mile rotation is slightly better than with conventional rear drive cars. It is not necessary to rotate the spare.

Unitized Power Package

The differential, located on the left hand side of the car, feeds torque to the left drive shaft directly and to the right drive shaft through a cross shaft (Fig. 8). To meet space requirements and reduce internal friction, the design uses a planetary gear set instead of the usual bevel gears to produce differential action.

The transmission is new, adapting the Turbo Hydra-matic design to front drive. It is mounted lengthwise of the car on the left side of the engine crankcase. This arrangement keeps the transmission from infringing on the passenger compartment and gives a flat toe pan and floor.

Oldsmobile's basic 425-cu in. Rocket V-8 engine has been modified to suit the front wheel drive car. Intake manifold and air cleaner were lowered to provide hood clearance and exhaust manifolds were revised for frame clearance. Larger intake valves (by 1/16 in.) and a special camshaft provide additional horsepower.

Mounted on the end of the engine crankshaft is the torque converter that feeds power to the transmission through a two-in. wide drive chain (Fig. 9). The development of a durable and quiet chain drive between the converter and transmission was essential to the design of the car. A number of approaches were evaluated during the early stages of the devel-

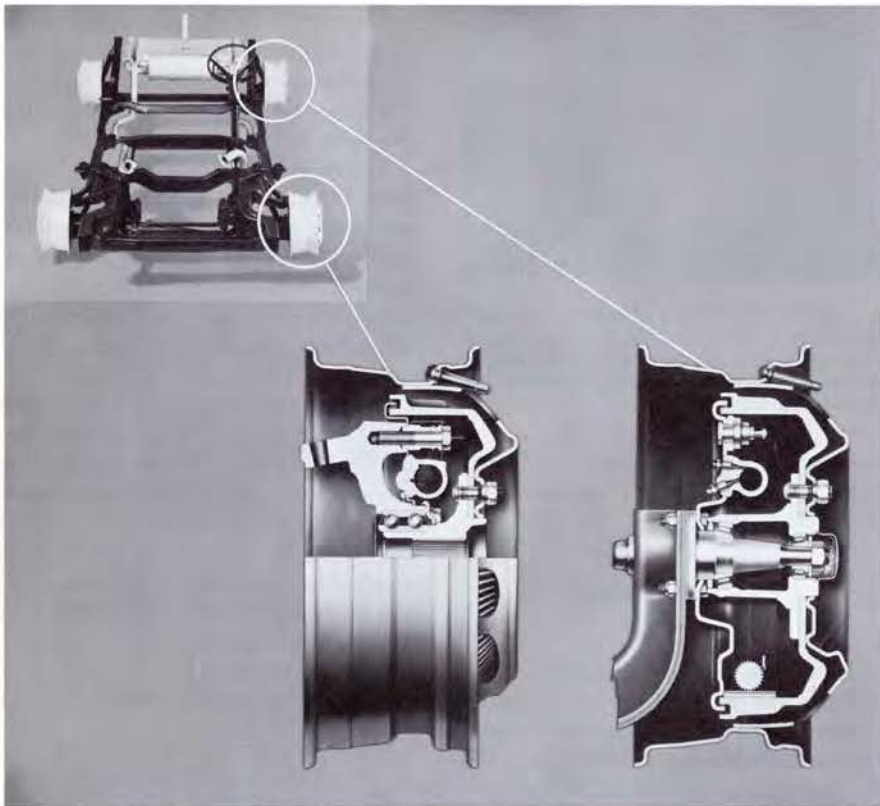

Fig. 7—FRONT AND REAR BRAKE CROSS SECTIONS.



Fig. 9—TRANSMISSION DRIVE CHAIN AND SPROCKETS. The Toronado transmission is split between the torque converter, which is attached to the rear of the engine, and the mechanical transmission, which is attached to the differential. These two sections of the transmission are connected by a chain and sprocket system to form the transmission assembly. The photograph shows a rear view of the transmission-engine unit with the chain cover removed.

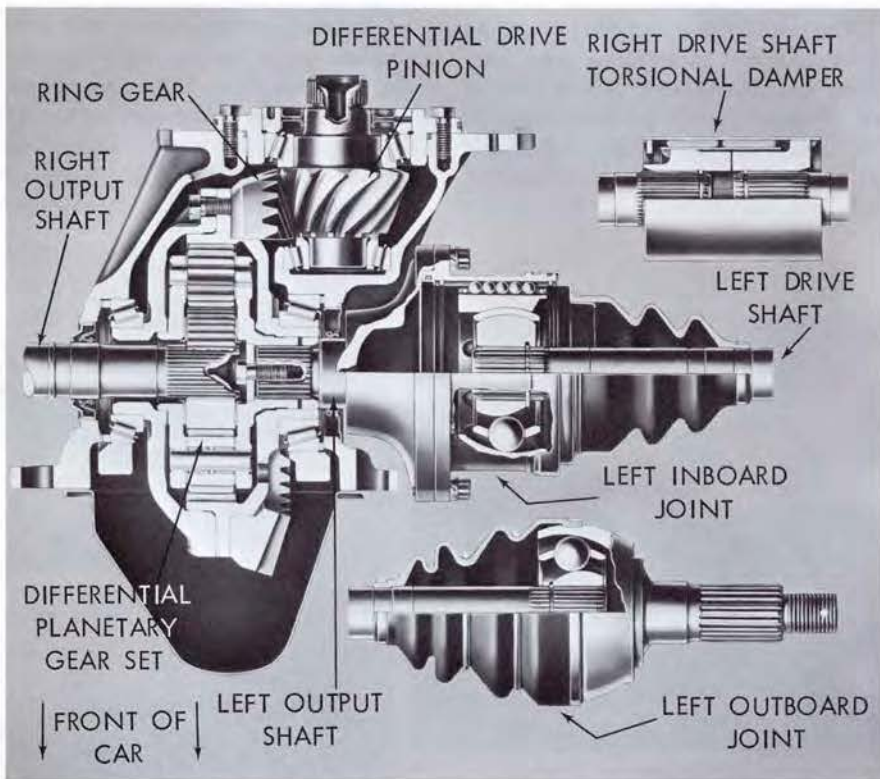

Fig. 8—DIFFERENTIAL ASSEMBLY AND DRIVE SHAFT COMPONENTS (PLAN VIEW). The Toronado differential is located on the left (driver's) side of the car and feeds torque directly to the left drive shaft. A cross shaft provides torque to the right drive shaft. The right drive shaft contains a rubber damper which cushions peak forces for maximum drive smoothness.

opment, including several gear drive arrangements. The chain finally was chosen for excellent durability. Satisfactory quietness with gears was unattainable.

The unitized power package consisting of the engine, transmission, and differential, is mounted 1.8 in. to the right of the car centerline for clearance conditions to the suspension (Fig. 10).

Body

Conventional body construction is used for the Toronado except that the frame ends at the rear spring front eye so that the structure from there rearward is integral in the body. The rear spring rear eye is mounted to this structure through a rubber isolated shackle.

Unusually good entrance and exit conditions are provided by an extra wide door which is positioned rearward in relation to the seat. This moves the lock pillar at the rear edge of the door farther away from the front seat giving a wide

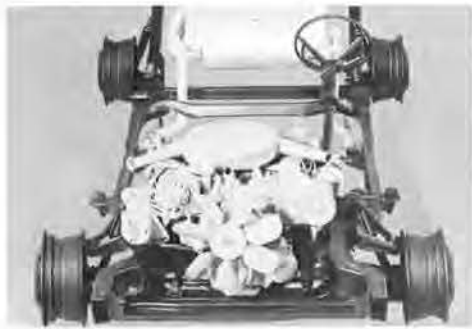

Fig. 10—UNITIZED POWER PACKAGE—ENGINE, TRANSMISSION, DIFFERENTIAL. The unitized power package (left) is mounted 1.8 in. to the right of the car centerline to obtain clearance conditions for the suspension (right).

spring rates in conventional cars would result in uncomfortably quick ride motions and hard impact on bumps. The Toronado, on the other hand, has a soft ride with these high rate springs.

In addition to their contribution toward good handling and roll control, another advantage of the high spring rates is the relatively small change in car height from unladen to fully laden. This gives good appearance at all passenger loadings and reduces the possibility of the suspension bottoming out.

By combining front wheel drive with suitable suspension design parameters, excellent handling has been achieved on the car. Particular attention was paid to such areas as weight distribution, front and rear roll steer, roll rate, kingpin inclination scrub radius, steering ratio, and tire characteristics. The result is a car with good directional control characteristics and considerable freedom from wander during highway driving in gusty crosswinds.

New Design Challenged Entire Organization

If the Toronado represented a challenging design and development problem, it presented equally challenging problems in engineering organization and management. As is the case with most GM car Divisions, the entire engineering organization at Oldsmobile (Fig. 13) engineers each car model. That is, the Engineering Department is not divided into special groups which work on certain

area of entry to the rear passenger compartment.

Headlamps are concealed in the front sheet metal and are raised and lowered automatically when the lamps are turned on and off. Actuator units are vacuum power cylinders similar to power brake cylinders, with the pistons connected to the headlamp assemblies through linkages (Fig. 11). These cylinders produce excellent opening and closing forces with good reliability.

The car uses a quiet draft-free ventilation system which eliminates vent windows and exhaust body air beneath the back window. Air enters the passenger compartment through inlets in the cowl sides and instrument panel. It then flows over rear seat passengers and out beneath the rear seat. From there it passes into a plenum through a one-way valve and out through a grille beneath the back window (Fig. 12). Elimination of the vent windows provides a quieter car with less wind noise when the windows are either open or closed. When the front window is partially open, air is drawn from the car the same as with a vent window but with less noise.

The instrument panel arrangement has controls concentrated in front of the driver, and the downward curve of the panel is away from front seat passengers to increase front compartment room. All controls and instruments are mounted in a console directly in front of the driver for easy access.

Styling

A great deal of attention was given to making the Toronado's appearance honestly reflect its mechanical design. The long hood, low body silhouette, and sleek, tapering rear end reflect the arrangement of car components. This functional design approach gives a feeling of rightness to the

car's appearance. The result is styling that makes the vehicle's design aspects strongly apparent.

Testing Was Essential to Design

It was possible to do most of the development and test work on the Toronado within the confines of the GM Proving Ground in Michigan, the Pike's Peak test facility in Colorado, and the Desert Proving Ground in Arizona. Final tuning on ride and handling was evaluated on public roads in several areas of northern Michigan and Arizona.

The use of high spring rates played an important part in attaining good handling and ride balance. Spring rates of the Toronado are 89 per cent higher at the front wheels and 57 per cent higher at the rear wheels than a comparable weight rear drive Oldsmobile. Equivalent

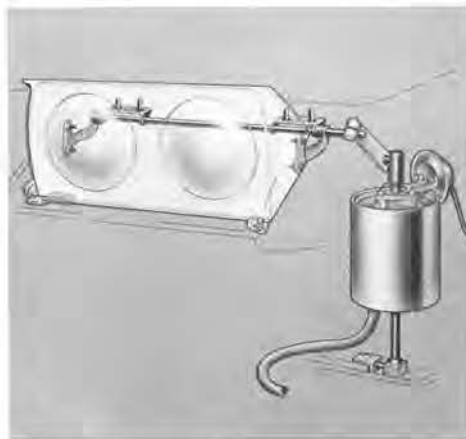

Fig. 11—HEADLAMP ACTUATOR. Vacuum power cylinders actuate the Toronado headlamp assembly through pistons connected to linkages. The headlamps are raised into position when the headlamp switch is turned on and lower when the switch is turned off.



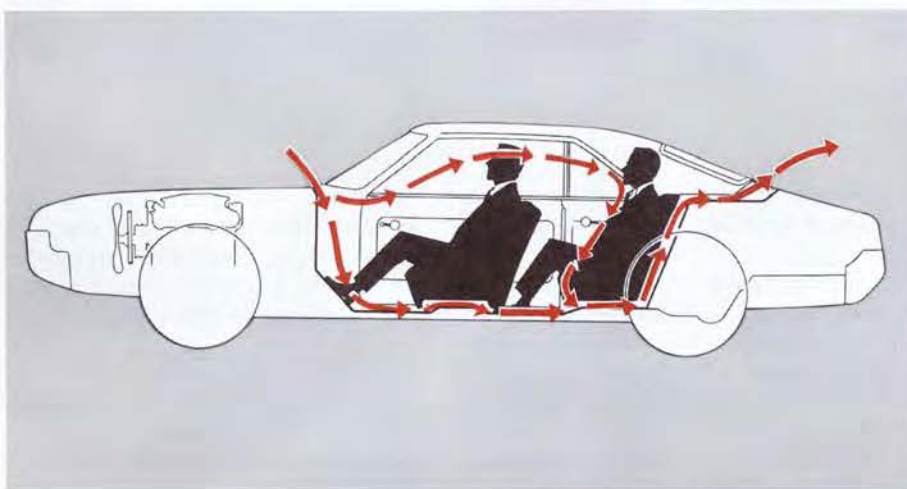
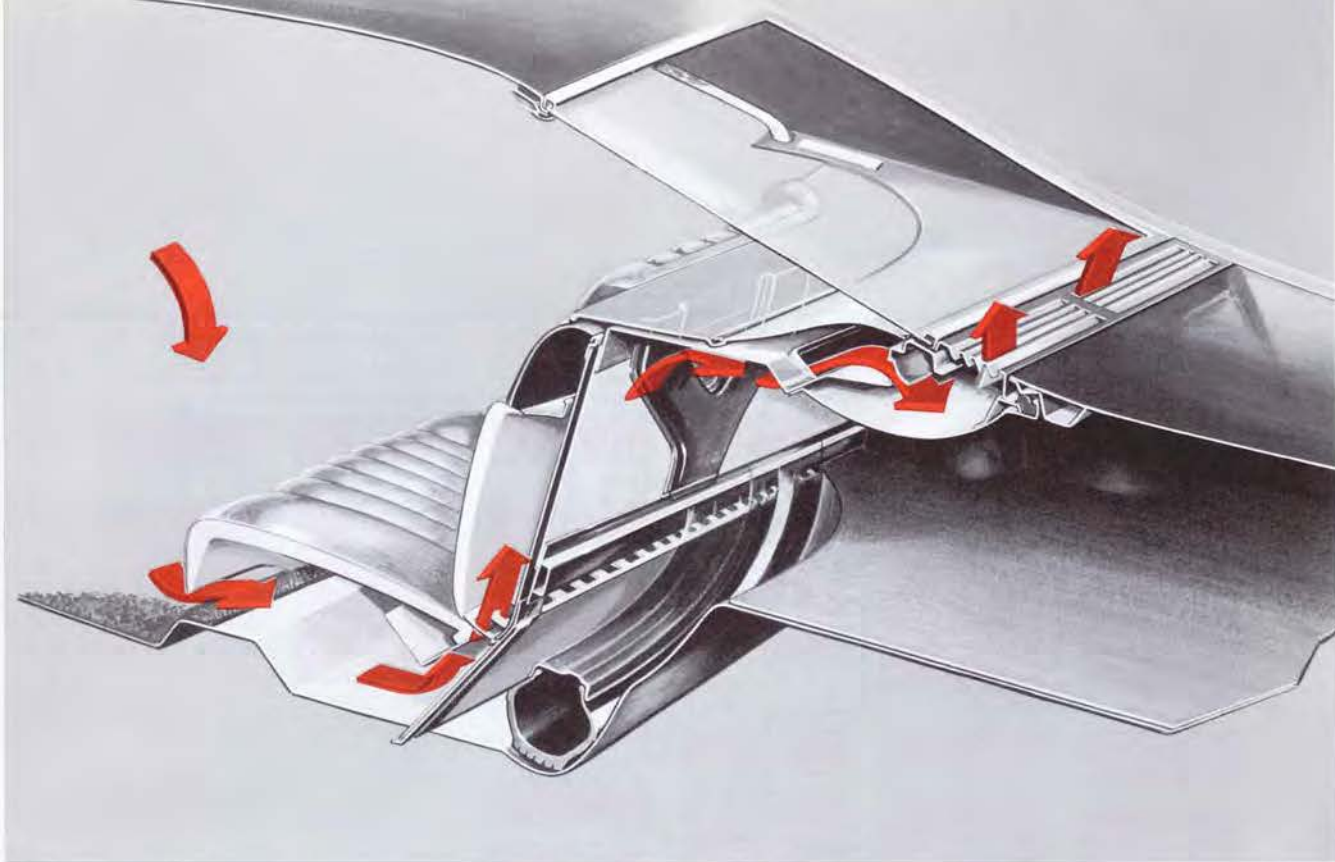

Fig. 12—VENTILATION SYSTEM. Air flow through the Toronado ventilation system is depicted at the left. The drawing at the top shows the system's plenum and exhaust grille at the rear of the car.

cars. Design and development work is divided according to the major car components—body, chassis, engine, and transmission. These design-development groups engineer their components for every car in the line. In addition, an Advanced Design Group works on new design projects of an exploratory nature, and an Experimental Group handles all testing.

The Toronado began as a project in the Advanced Design Group. Later, when the decision was made to proceed with the car for 1966 introduction, the Toronado was turned over to the regular design and development groups to handle the work

required to ready the car for production.

At that time consideration was given to the possibility of maintaining the car as a separate project and having specialists from the various groups work on the development. The thought was that perhaps progress could be followed better with the work under the control of one relatively small group. This approach was rejected because it would not permit bringing the abilities of the entire organization to bear on the project.

Another advantage was gained from handling the program under the regular method. The engineering organization

and the individuals within it are stronger for having participated in the work because of their pride in the accomplishment, as well as the development of their capabilities as engineers.

The method of organizing the work and the efforts and talents of the Oldsmobile people were major factors in the successful development of this new automobile. However, extensive use was made of two other important elements—the computer and accelerated laboratory testing. These tools are becoming increasingly important to the operation of any large scale engineering activity because they

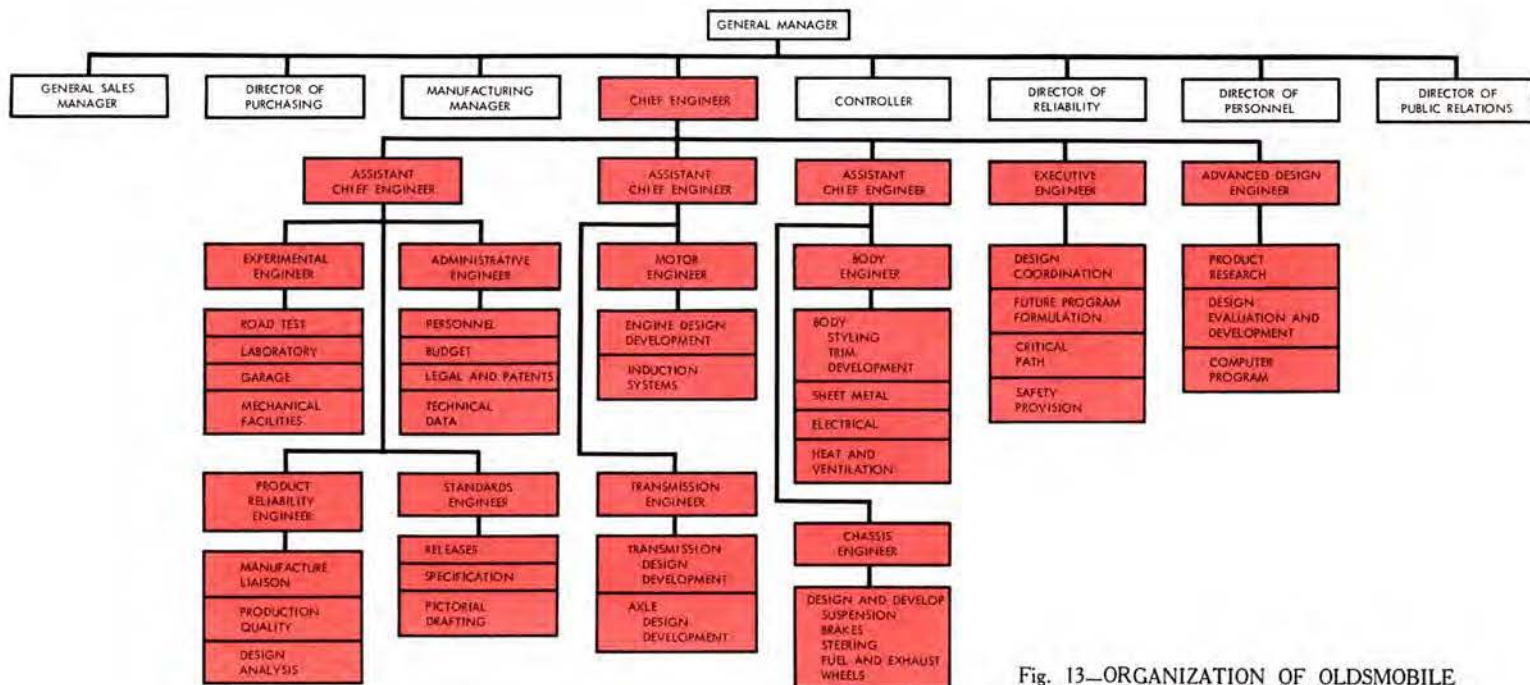

Fig. 13—ORGANIZATION OF OLDSMOBILE PRODUCT ENGINEERING ACTIVITIES.

enable rescaling time. Both permit accomplishing in hours what used to take weeks.

The computer was used for tasks from calculating drive train stress and maintaining the critical path follow-up system to the issuing of parts lists. Accelerated laboratory tests were set up in advance for almost every new part in the car during the initial design stage. They enabled test cars to be built with parts which were more certain to pass the more time consuming Proving Ground durability tests. Further, they permitted quick solutions to problems that would have taken months if worked out by a series of runs on test cars. In addition, the greater number of test samples that were able to be run provided increased understanding of such things as suspension and drive system durability, which covered adequately the full spread of fatigue life from minimum to maximum.

As an example, perhaps the most important phase of the laboratory test program centered around the front wheel drive components—the engine, transmission, differential, and drive shaft. To test this complete assembly a method was

developed to evaluate quickly the durability of the design in advance of building test cars.

Testing all drive train components simultaneously was an ambitious project in laboratory evaluation. A complete assembly was connected through the front drive shafts to two absorbing dynamometers with the engine providing the driving power. To simulate actual driving on a durability schedule, magnetic tape on a multiple-channel programmer controlled engine speed, throttle opening, transmission driving range, and individual front wheel speeds. The control tape was made while driving a vehicle over the durability course at the GM Proving Ground. When installed on the programmer in the laboratory it repeated the schedule exactly, for over 900 miles a day. This had the advantage of rapid evaluation because it eliminated maintenance down-time, permitted exact reproduction without weather and human variables, and allowed visual evaluation of the components while the test was in progress.

The final phase of the Toronado program involved the building of 37 pilot

production cars. These cars, completed in May 1965, provided manufacturing people advance experience in assembling the car and gave three months of final test experience on production cars.

Conclusion

The development of the Oldsmobile Toronado involved many hours of challenging engineering and the participation of the entire engineering organization. The result of all the planning, design effort, development work, testing, and retesting is a completely new breed of automobile.

An added benefit of the Toronado development to Oldsmobile has been the pride of accomplishment shared by all the Division's engineers. Each year, as the new models are produced and reach the market, the automotive engineer derives pride and satisfaction from his contributions to a better product. The Toronado—being an exceptional automobile—has given Oldsmobile engineers an even greater opportunity to apply their professional skills, and has yielded even greater rewards of satisfaction.

Product Engineering in General Motors

By HARRY F. BARR
Vice President in Charge
of GM Engineering Staff

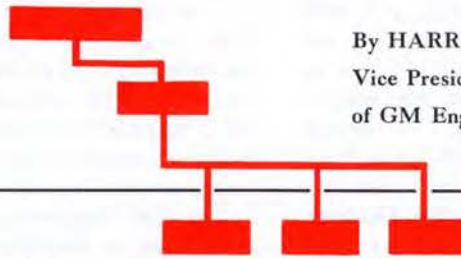

THE manner in which the product engineering assignment is performed in General Motors is not readily apparent

nor easy to explain to an outsider, or to many General Motors employes who are not engineering oriented. An ideal exam-

Staffs assist in product development; Divisions have final responsibility

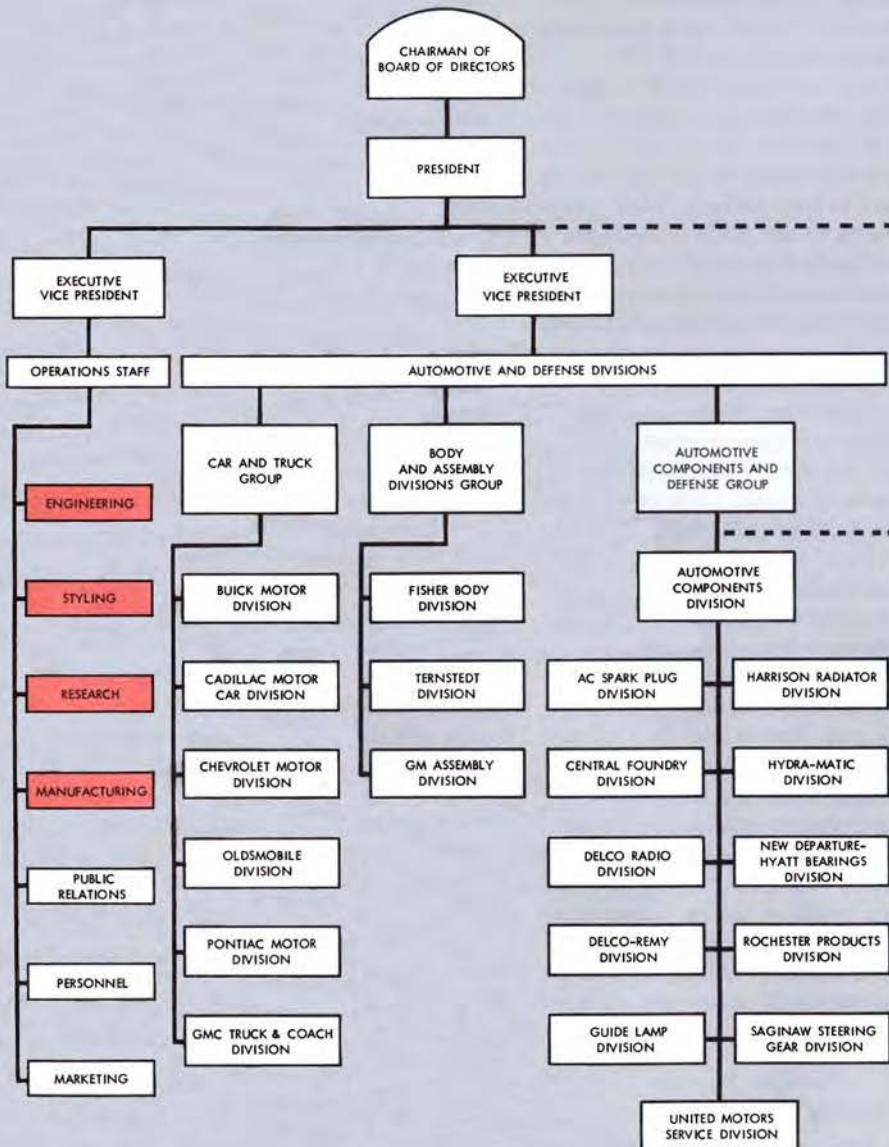

ple for such an explanation is the recent development of a completely new passenger car. That car is the Toronado by Oldsmobile, which was known as the XP-784 during its development.

Seldom has the development of any new vehicle utilized the combined efforts of so many different design, engineering, and production units of General Motors. The XP-784 program, therefore, is very well-suited to demonstrate the coordinated engineering effort of the car Division, supplier Divisions, and Central Office Operations Staff (Fig. 1). This and the next issue of the *General Motors Engineering Journal* will attempt to show how such a project starts, how it proceeds, and how it finally concludes as a production item.

Division Has Final Responsibility

The final responsibility for engineering the product in General Motors rests with the producing Division. This is an inherent facet of GM's decentralized method

Fig. 1—ORGANIZATIONAL RELATIONSHIP OF OPERATING DIVISIONS AND CENTRAL OFFICE STAFFS. This partial representation of the General Motors organization chart indicates the relationship of the Central Office Staffs and the car, body and assembly, and component Divisions. Each operating Division, under GM's policy of decentralized operations, has final authority and responsibility for its own products—including design, development, production, and sales. The Central Office Staffs located at the GM Technical Center (shaded on chart) provide technical consultant and development services for the Divisions as required.

of operation. Each Division has its own engineering, manufacturing, and sales responsibility. Thus, the Division alone is responsible for what it offers to its customers. In carrying out this responsibility, the Division has its own research and development activities in its engineering department to help plan the future products it might offer. However, this is usually a comparatively small activity when compared to the facilities set aside for this purpose alone at the General Motors Technical Center, as well as the customer research activities in the Marketing and the Financial Staffs. The Technical Center units and other Staffs, however, only provide services for the Divisions, and do not have control over the Divisions' final decisions regarding their product activities.

The strictly product and production oriented Staffs at the Technical Center—the GM Engineering, Styling, and Manufacturing Staffs—have the assignment of exploring the future in components, concepts, and manufacturing methods. The GM Research Laboratories, also at the Technical Center, contributes new scientific knowledge to the Divisions and other Staffs as well. There is no central "idea" outfit in General Motors, since with these Central Staffs, the car Divisions, and the many supplier Divisions, each with imaginative and creative engineers, there is no shortage of new ideas.

General Staffs Provide Important Services

The functions and activities of the producing Divisions are fairly evident. However, the Staff activities require more thorough definition. Since this issue of the *Journal* will deal with the Engineering and Styling Staffs, the explanation will be confined to them.

The GM Styling Staff is involved in designing the appearance of every General Motors product whether it is a car, truck, locomotive, or simply a box in which parts are merchandised. Of course, the automotive exterior design activities of Styling are best known. However, Styling also is responsible for interior design, body development engineering, and new vehicle configuration concepts. Strange as it may seem, the Styling Staff has more engineers than stylists, and the body development engineering activities are larger than the exterior styling activities. Body development consists, in simplest terms, of establishing basic package speci-

fications for the various car lines and developing new configurations for the body components. Styling vehicle configuration concept studies are aimed at new ideas which will provide an appealing product for the customer with more passenger comfort, safety, and convenience, more utility, and more flexibility.

The GM Engineering Staff, on the other hand, is involved in the development of mechanical components for future vehicles and concepts. Specific Groups within the Staff work on engines, transmissions, and suspension systems. Another Group specializes in the remaining major vehicle components, such as bodies and frames. While each Group has its specific assignments, they all may work in related or adjoining areas of the vehicle as the need arises or in unison on a completely new concept, such as the XP-784.

As is the case with all Staff activities, since the Divisions are responsible for their own products, the services of the Styling and particularly the Engineering Staffs are strictly advisory. Thus, much of the work at the Staffs is exploratory and does not find its way directly into the final product. However, elements of the advanced Staff work provide information the Divisions can use in the final design.

Finally, the Division is on its own. Many engineering hours go into the final design to produce a vehicle that can be built on the Division's production equipment at a reasonable cost. However, the Staffs are still available to help the Divisions with any problems that may arise in the final design. Such things as noise, durability, reliability, and ease of fabrication frequently fall into this area.

Of course, safety is constantly in the forefront of consideration at both the Division and Staff levels. Few, if any, parts, components, or concepts are developed or used in such a manner that safety is not a major consideration. Virtually every test, either in the laboratory or on the road at the GM Proving Ground, has some major or several minor safety connotations. The consideration of safety in General Motors products begins on the drawing board and carries through every step of its development and manufacture.

Toronado Program Involved Many GM Units

It is difficult to say just where the initial idea for the Toronado front wheel drive car developed. As is usually the case, the code designation XP-784

stemmed from the experimental project designation number in one of the Staffs or Divisions. XP-784 happened to be the designation of a front wheel drive concept in the Styling Staff. However, this project grew out of earlier work on a front drive concept which culminated in a dream car in the 1955 Motorama known as the LaSalle II. Engineering Staff assisted Styling by designing the power package for this vehicle. Later development at the Engineering Staff progressed through a number of unitized power package (UPP) concepts installed in 1962 Oldsmobile body conversions and, later, on prototypes. However, at much the same time, Oldsmobile Division itself, through its Advanced Design Group, was proceeding along a similar and parallel path. Their first UPP configurations were installed in small size car (F-85) bodies. Their work contributed significantly to the early development of the concept and allowed the Division and the Staffs to work closely together on the development of a practical and productively feasible design.

The Staffs involved in the XP-784 program as well as Oldsmobile and Fisher Body Divisions reviewed all phases of the development program. The design of production components was divided among several Divisions where the parts would be produced so that Oldsmobile would not carry the entire engineering burden. These assignments were as follows: Oldsmobile Division—engine, front and rear suspension, and sub-frame; Fisher Body Division—body structure and passenger accommodations; Hydraulic Division—transmission; Buick Motor Division—differential; and Saginaw Steering Gear Division—front drive units. Of course, many other Divisions and Staffs were engaged in developmental work on other components, and the Staffs continued to assist Oldsmobile as their needs required.

Conclusion

The success of a venture of the magnitude of the Toronado depends upon engineers working together. This is not always easy because two individuals or groups can be very competitive in trying to prove one or the other of parallel paths to a common goal. Nevertheless, they are engineers who have a common goal. Teamwork is their most valuable resource, and a reliable, safe, and practical product their goal.

The Development of a Unitized Power Package for a Front Wheel Drive Vehicle

By JOHN D. MALLOY
General Motors
Engineering Staff

Engineering and development work on a unitized power package (UPP) for a front wheel drive vehicle began as early as 1954 at the GM Engineering Staff. This work was performed for the LaSalle II, an experimental show car designed for the 1955 GM Motorama. Unitized power package work at the Engineering Staff involved both the Power Development and Transmission Development Groups. These two Groups conducted many preliminary studies and developed several product design concepts which contributed to the final development of the unitized power package by Oldsmobile Division for the 1966 Toronado.

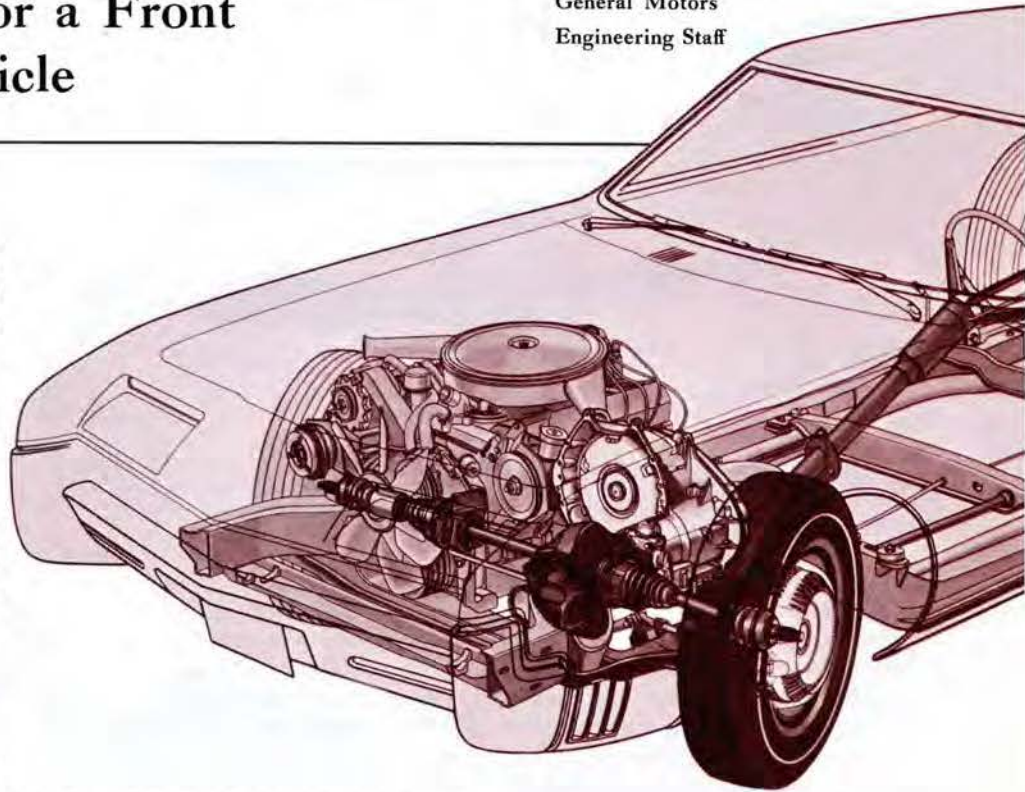

Two of the developmental groups at the GM Engineering Staff closely associated with unitized power package (UPP) and front wheel drive design studies have been the Power Development and the Transmission Development Groups. The Power Development Group designs, builds, develops, and tests new power plants, controls, and accessories for both passenger car and commercial vehicle use. The Group is staffed to design and build special test equipment for its developmental projects when required. The Transmission Development Group's primary activity is the design and development of prototype automatic transmissions for consideration by GM car Divisions as production equipment. The Group has played a major role in the development of most of the torque converter type automatic transmissions produced by General Motors. Transmission Development also performs research and development work in such associated areas as hydraulic control systems, friction studies, clutch design, hydrodynamic and hydrostatic systems, and other areas concerned with means and methods of power transfer.

The Power Development and Transmission Development Groups first became involved with UPP and front wheel drive design studies in 1954. At that time a

UPP and front wheel drive design was developed for the LaSalle II, an experimental show car (Fig. 1) displayed at the 1955 GM Motorama. The design considered the use of an automatic transmission. Time limitations, however, did not permit the UPP concept to be fully developed for the LaSalle II, although this and other studies made by the Engineering Staff for the GM Styling Staff demonstrated the potential of the concept and generated early interest at Oldsmobile Division.

Some of the advantages offered by the UPP were potential weight savings and compactness gained by combining the engine, transmission, final reduction gearing, and differential into one package; the elimination of the floor hump; and the opening of new approaches to vehicle styling.

The knowledge gained from the LaSalle II and other following studies contributed greatly to the eventual development of the UPP concept for the Oldsmobile Toronado.

Engine Program for UPP Summarized

From the viewpoint of the engine designer, an ideal UPP should:

Engineering Staff studies aided final front wheel drive development

- Be compact, especially regarding the space requirement ahead of the car body
- Place no serious design limitations on the engine
- Accept existing engine designs with a minimum of modifications.

The Engineering Staff prototype UPP was designed to provide for any of the existing V-8 engines in General Motors with few modifications. The fan drive, cooling system, and the heating and air conditioning system were to be of conventional type; however, the forward position of the engine was to provide more compartment space for a heating and air conditioning package.

The engine chosen for the prototype design was a 429-cu in. production unit (Fig. 2), the largest GM passenger car

*Two-Speed, Dual-Path
Transmission Used in
Early Prototype*



Fig. 1—LA SALLE II. One of the experimental show cars displayed at the 1955 General Motors Motorama was the LaSalle II. A unitized power package and front wheel drive design study was made for this vehicle by the GM Engineering Staff, but was not completed in time for the Motorama showing.

engine available. This engine provided maximum performance in a minimized weight package. For the first time in many years the engine could be mounted horizontally; the need for a 4° inclination to reduce propeller shaft angularity was no longer a design consideration. In fact, the engine could be tipped in the opposite direction if required to improve hood clearances.

The original design called for the crankshaft to be extended to provide the input to a torque converter. This was not desirable from the engine designer's

viewpoint. The extension would present problems in shipment of the engines and in separating the engine from the transmission for service. During a subsequent redesign of the transmission, the need for the crankshaft extension was eliminated so that production crankshafts could be used.

The intake manifold was similar to the production engine design, except that it was of minimum height, had a horizontal flange for the carburetor, and was cast of aluminum to reduce weight. A minimum height for the air cleaner was used.



Fig. 2—PROTOTYPE UNITIZED POWER PACKAGE. A 429-cu in. engine was used for the prototype UPP developed by the GM Engineering Staff. This was the largest engine available for application in the UPP vehicle. Front end mounting locations for the distributor and oil pump permitted a greater degree of flexibility at the rear of the engine for mating with the automatic transmission.

Front drive cars are not new as attested by the existence of several European designs, but the use of an automatic transmission for a production front wheel drive vehicle is unique. This system eliminates a number of problems associated with mechanical transmission front drive arrangements, particularly when used with large, higher powered vehicles. The use of a fluid member in the drive line cushions the wheels from sudden torque changes which feed through with mechanical gear concepts.

Oldsmobile Division began front wheel drive studies during the development of an intermediate size car that subsequently emerged as the F-85. The Division requested that the GM Engineering Staff design and build a two-speed transmission for a package using a chain transfer drive arrangement. This package was of three basic parts—engine, transmission, and final drive—and, when installed in an experimental vehicle, became the first running installation in GM's front drive program.

Concurrent with the Oldsmobile program, the Engineering Staff began to develop a compact arrangement with a gear transfer drive. This unit used a two-speed, dual-path transmission mechanically similar to a production dual-path turbine drive transmission developed earlier by the Staff (Fig. 3) and a bevel gear differential driving ball and trunnion type output universal joints. The torque converter was mounted directly to the extended engine crankshaft and was of dual, or split, path design.

By using a converter with a high torque multiplication ratio at low car speeds, it was possible to cover performance requirements with a two-speed unit. In forward drive, low gear, the input to the 1.60 to 1 ratio gear reduction was from the converter turbine element with a torque ratio of 2.60 to 1 at stall. The overall multiplication ratio was the product of the converter and gear set torque ratios. In high gear, the gear set was essentially inoperative as the reaction element was now clutched to the engine. In reverse gear, by use of a unique clutch arrangement, the turbine was made the converter reaction element and the stator became the input to the gear set. As its

direction of rotation was opposite to the converter impeller, this drive, which was 1.60 times input engine torque at stall, in conjunction with a 2.60 ratio gear reduction, gave an overall ratio of 4.16 to 1, the same ratio as in low forward gear.

The differential was the common Revacycle gear type. The inboard universal joints were of double ball and trunnion design, which allowed the necessary lateral freedom and angular displacement. Extensive dynamometer and road testing of this unit, which included a trip to the western U.S. for a total of over 6,000 miles, verified performance and handling predictions for this type of vehicle drive.

*Revised Prototype Used
Three-Speed Transmission*

Encouraged by these results, the Engineering Staff decided to proceed with the reworking of several Oldsmobile cars modified to accept the UPP and front wheel drive. The package was to have a three-speed transmission to give the desired vehicle performance.

Drive from the engine to the transmission was through a three-gear train with a torsional spring damper assembly to minimize torque fluctuations. Total weight of the transmission and final drive package was 235 lb, a savings of 170 lb over the comparable parts in a conventional drive unit.

The basic transmission mechanical configuration was taken from a previous experimental unit. By using a simple planetary gear set in conjunction with a Ravigneaux gear set for first gear and reverse, flexibility of second gear ratio choice was achieved, and a dual-path drive arrangement was provided in third gear. Proper gear ratios were determined from computer performance predictions using a program developed by the Engineering Staff. Knowing engine data, converter characteristics, and vehicle size and weight, the most advantageous combination of gear ratios was determined to give the desired performance and economy. This analysis, or matching of transmission to engine and vehicle for optimum results, was done easily and quickly with the aid of the computer program.

Since the three-gear transfer drive train from the engine to the converter was the newest area in this design, an extensive test program was initiated well before the design was finalized. Because these gears

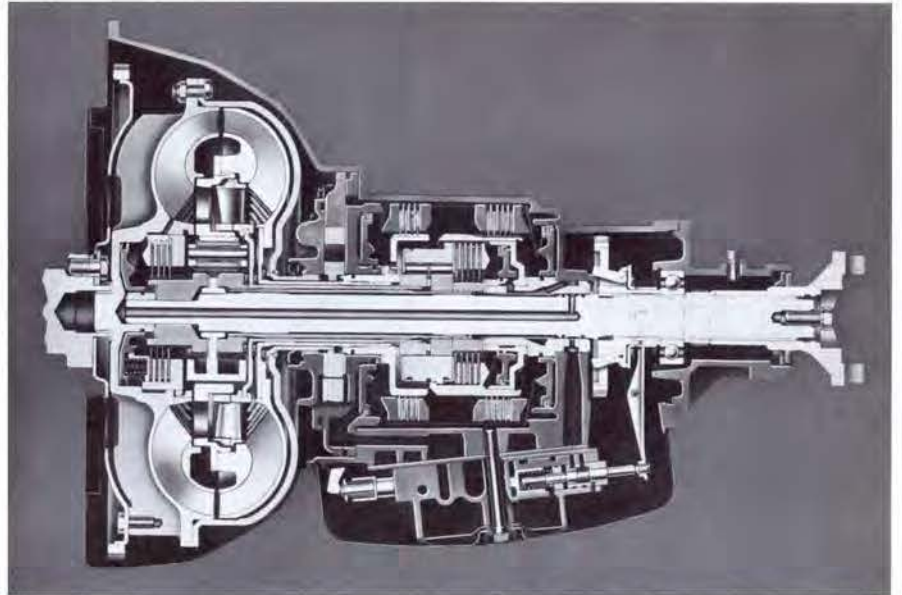

Fig. 3—TWO-SPEED, DUAL-PATH TRANSMISSION. A dual, or split path, turbine drive transmission was used in the Engineering Staff's early UPP design. The dual-path design provided a parallel mechanical drive torque path that was added to the hydraulic path through the converter to give the total drive to the final reduction gearing. This partial mechanical drive reduced the load on the converter allowing it to operate at lower element differential speeds, or essentially less slip, in direct drive range. The fluid path retained the drive line smoothness associated with hydraulic drives. The particular dual-path design shown here is a pre-production prototype of a unit that is not now being manufactured.

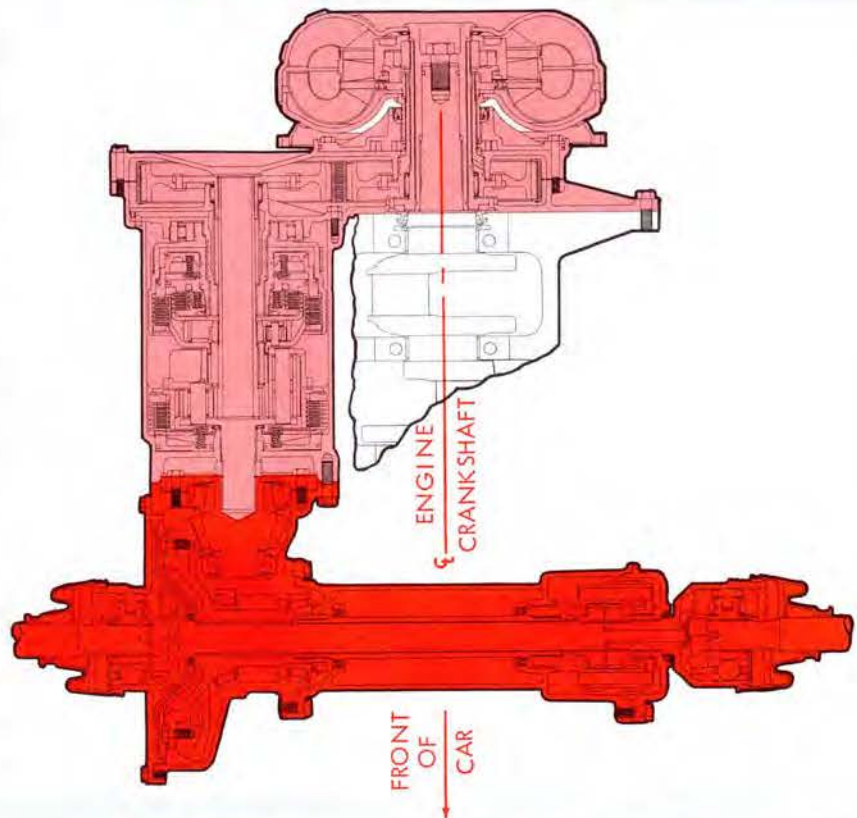

Fig. 4—TORQUE CONVERTER, TRANSMISSION PROTOTYPE CONFIGURATION. The engine crankshaft was extended to provide space for a chain drive placed between the converter turbine and the transmission, which was placed on the right side of the engine.

were engine driven and, therefore, subject to torque pulsations and high pitch line velocity, noise considerations and durability were of prime importance. Torsional damper studies were made to verify location and design. Several types of gearing were proposed, including herringbone types for balanced thrust, experimental tooth profile gears with balanced loading, helical types of various pitch and helix angle, and straight spur gear combinations, all with various damping media to control noise.

Three units of this design were completed and, after considerable dynamometer testing, were installed in the cars. Extensive test work was done at the GM Proving Grounds in Michigan and Arizona. The three units were taken on a 9,000-mile test trip through the western U.S. and Canada, encountering a variety of road and driving conditions. The handling and performance of these vehicles was exceptional and verified the soundness of the basic design approach.

Further Studies Led to Production Prototype Design

Increased interest by Oldsmobile prompted further study of the UPP concept for high performance vehicles. This study led to the first design approach to the eventual unit configuration arrived at for the production vehicle.

The design selected had the transmission assembly placed to the right of the engine (when viewed from the driver's seat) and on parallel centers. The torque converter was fastened directly to the engine crankshaft, which was extended to provide space for a chain transfer drive between the converter turbine and the transmission proper. Placing the torque converter on the engine side of the transfer drive provided torque multiplication, necessary flywheel inertia, and a fluid cushioning element to smooth out engine torque pulsations (Fig. 4).

The chain drive mode of transfer was selected because of less restriction on center distance than with gears and because it allowed the transmission to be placed alongside the engine, thereby giving a shorter overall unit. The experience gained during the previous study for Oldsmobile indicated that this method of drive transfer was entirely feasible.

Exhaustive development and test work was begun to investigate areas of possible concern. The two most important areas were chain noise and durability. This

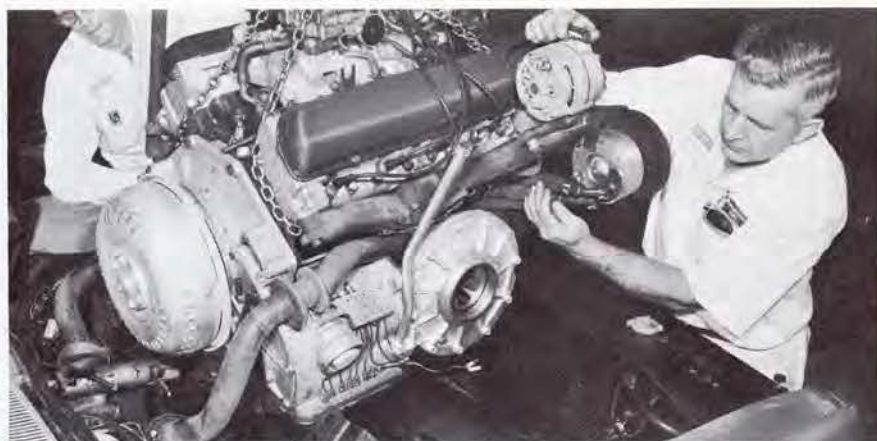

Fig. 5—PROTOTYPE UPP INSTALLATION. In addition to the UPP units installed in modified vehicles for transmission and other test work, another unit was used for dynamometer testing.

program paralleled chain transfer investigations at Hydra-matic and Oldsmobile Divisions. Two dynamometer chain test setups were built to develop the durability of the chain drive. Both setups had the engine driving Powerglide transmissions with a chain transfer drive placed between

the converter output and transmission proper. One unit was used primarily for low load, high speed, or what could be considered normal expressway operation. Control of the unit was automatic, varying throttle position, gear selection, and dynamometer loading to follow a selected

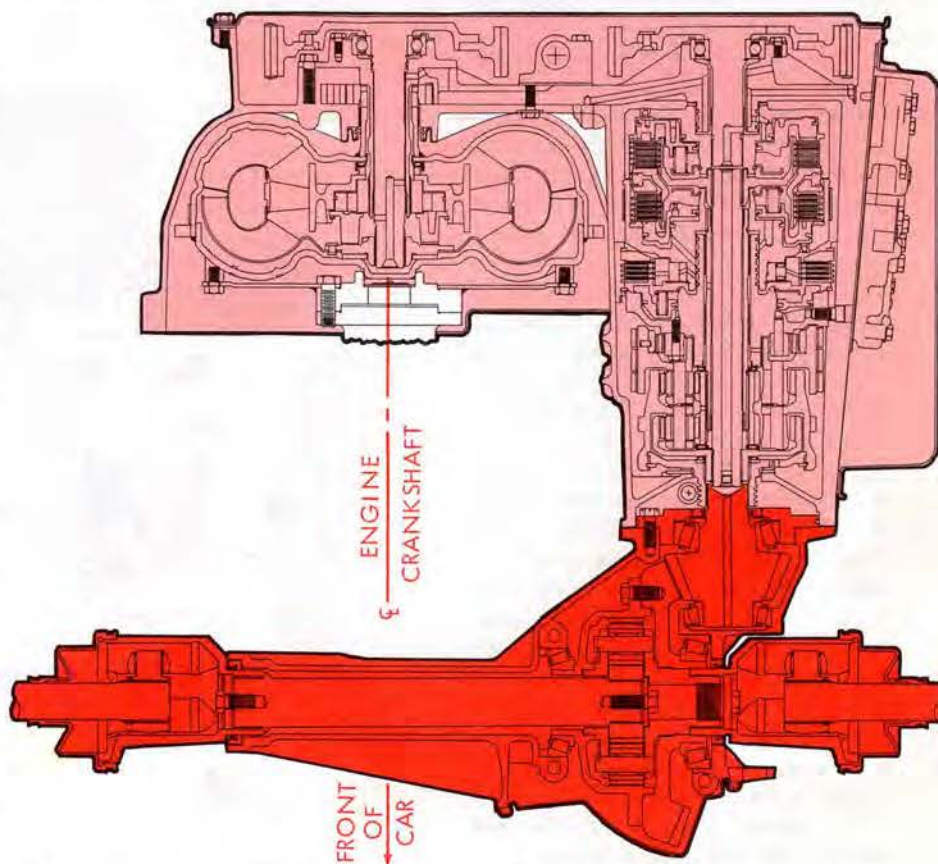

Fig. 6—PRE-PRODUCTION UPP TRANSMISSION DESIGN. When the decision was made to use a UPP for the 1966 Toronado, the Engineering Staff redesigned the existing prototype UPP to arrive at an acceptable production package. Shown here is the redesigned UPP. The converter was mounted directly to the crankshaft, but this time it was placed between the chain drive and the engine. The design also allowed the use of a slightly modified Turbo Hydra-Matic production three-speed transmission, which was placed on the left side of the engine.



Fig. 7—PLANETARY DIFFERENTIALS. Shown here are the two types of planetary differentials tested in the pre-production UPP design. The design at the left, a radially compact unit, had a carrier input and sun gear outputs to each wheel. The design at the right, and the one eventually selected for the production design, had a ring gear input with a sun gear and carrier output.

test program. Working with the chain manufacturer, many variations of chain and sprocket were tried.

The second dynamometer test unit,

which also was controlled automatically, was programmed to a standard GM Proving Ground transmission test schedule. It was a more severe test with a wide

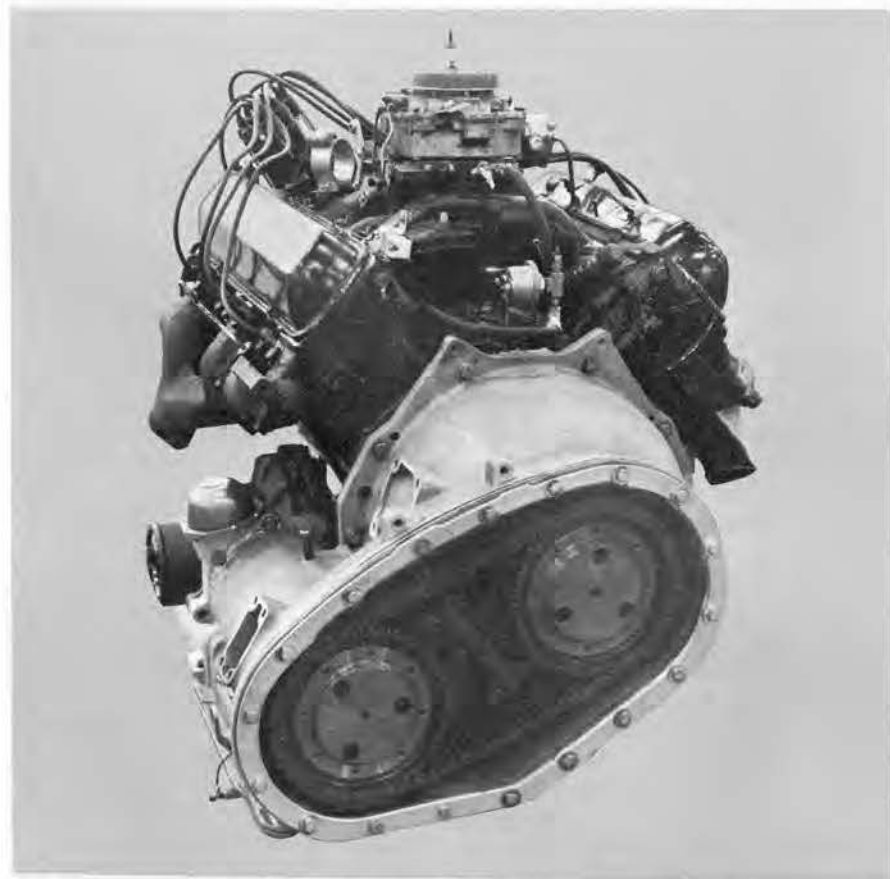

Fig. 8—DYNAMOMETER TEST UPP UNIT. The chain transfer drive had a plastic cover to allow high speed movies to be made to study chain action under various operating conditions.

range of loads and speed conditions. Four thousand miles of operation on this accelerated work schedule is considered to be acceptable. The same type of chain that passed the high speed test ran over 39,000 miles on this schedule. These tests indicated that chain durability was satisfactory for this type of application.

The transmission selected for this design was basically the same gear arrangement used previously, but without the dual-path feature. Since the torque converter was now separated from the transmission gear box, a dual-path design would have required an additional transfer drive to bring a mechanical path, independent of the converter, down to the transmission. This unit, therefore, was designed as a straight hydraulic drive, with all the torque passing through the converter. The longitudinal arrangement of the unit required a cross axis final drive. A spiral bevel setup was chosen with no pinion offset. Because of the resulting low sliding velocity and load factors, as compared to a conventional hypoid type axle, it was possible to use regular transmission oil as the lubricant, thereby allowing a common oil system.

The differential was a planetary type with the carrier as the input member from which the torque divided evenly through intermeshing sets of pinions to identical sun gear outputs. Because of the small housing diameter required for this type of differential, it was possible to mount it on the left-hand side of the engine, without interfering with the engine oil pan. This position minimized the required offset of the engine to the vehicle centerline, while still retaining equal length driveshafts to the front wheels.

While units installed in modified Oldsmobiles (Fig. 5) were used for basic transmission and other test work, one unit was put on dynamometer test. The two areas of development were the transfer chain noise level and the inboard universal joints. The more promising chain and sprocket combinations from the dynamometer chain test fixture were tried in a car for evaluation in their actual environment. Universal joint test work verified the need for constant velocity joints both inboard and outboard at the wheels to give the smoothest drive line.

*Production Transmission
Adapted for UPP*

The promise shown by this design resulted in the decision to use a UPP unit

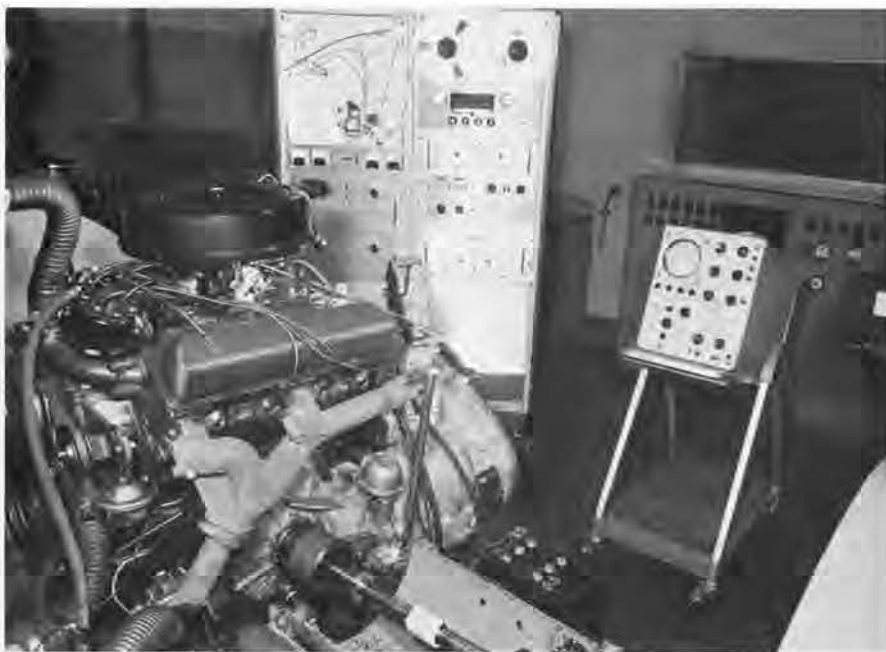

Fig. 9—DYNAMOMETER TEST SETUP. The UPP units were subjected to an accelerated dynamometer test schedule to check functional operation and durability. The UPP unit—engine, transmission, final drive, and axle assembly—was coupled to two eddy current braking dynamometers to simulate grade and road loads. Each dynamometer was in series with flywheels of equivalent car inertia. The controls for the dynamometer test were designed by the Engineering Staff.

in the 1966 Toronado. Working closely with Oldsmobile, the Engineering Staff started a redesign study with the objective of arriving at an economically acceptable production package using the basic longitudinal configuration. To reduce tooling expense, the drive unit was to use as many current production transmission parts as possible, but still be flexible enough to accept later design changes if required (Fig. 6)

The converter again was mounted directly to the engine crankshaft, but between the chain transfer drive and the engine. This allowed the use of a standard engine crankshaft and standard converter elements, which were basically Turbo Hydra-matic parts. By increasing the chain sprocket center distance, it was possible to move the transmission assembly further back alongside the converter assembly. This increased space allowed the use of the Turbo Hydra-matic production automatic three-speed transmission assembly almost intact. Due to the opposite direction of rotation, gear helix angles were reversed to control thrust direction. Free wheeler and band units were revised for direction, but basically the transmission section used existing production parts. The axle was of hypoid gear design with a 0.570-in.

pinion offset above the ring gear center, considered by the gear manufacturer to be the maximum allowable for use with type "A" transmission oil as the lubricant. This offset was necessary to maintain the proper ground clearance of the transmission oil pan. Provision was made to allow use of different type fluids in the axle and transmission as an option.

The differential was a planetary, double-pinion type, with the ring gear as the input (Fig. 7). The sun gear was one-half the size of the ring gear which, along with the carrier as an output member, transferred one-half the input torque, resulting in an equal torque split to both wheels. This compact design required minimum axial space and allowed the differential to be placed next to the final reduction ring gear eliminating the need for a primary differential input shaft as required in the former design.

As was previously determined, inboard universal joints would have to be the constant velocity type. Saginaw Steering Gear Division proposed a constant velocity joint of sufficient capacity that fit the existing space. This design consisted of a six-ball joint, similar to the one used at the outboard end of the drive shaft, in combination with a ball spline for axial travel allowance.

A dynamometer test setup was built for noise studies of the chain proposed for this unit. Basic chain durability had been proven in previous tests, and a concentrated effort now was made to assure a design of acceptable noise level. Using a prototype transmission case, the chain transfer drive environment was simulated accurately. The unit was enclosed completely in a sound insulated box to mask extraneous noise. Instrumentation was incorporated to measure noise level, frequencies, and—by use of highly sensitive accelerometers—the most active areas of the drive environment. A plastic cover was made for the chain case so that high speed photography could be used to study chain action under various speed and load conditions (Fig. 8). Areas investigated included modified tooth profiles of both chain links and sprocket teeth, various forms of damping within the chain as well as in the surrounding areas, chain guides and slack adjusters to control position and tension, and various forms of isolators to prevent noise transfer to the unit case. This investigation paralleled quite closely the procedure normally followed in gear train noise analysis.

Several combinations indicated promise and the experimental transmission design was released for parts. A total of seven units eventually was built. Three were retained by Engineering Staff, two for installation in cars, and the third for dynamometer test work. The two car units were used by Engineering Staff Groups for evaluation and demonstration to management. The third unit was placed on a dynamometer setup on an accelerated test schedule to check functional operation and unit durability. The remaining four were for Divisional use.

The dynamometer test setup allowed around the clock component testing regardless of weather conditions, and provided ample room for observation and desired instrumentation that otherwise would not have been available. Automatic control eliminated errors due to human variables that are possible when a test cycle is repeated manually and required minimum attention during operation. The Engineering Staff designed and built the controls for this unit (Fig. 9).

The specific test cycle selected was based on the GM Proving Ground 7-11 Hill Route Schedule. This is a common test for transmission, rear axle, and differential assemblies. The Schedule consists

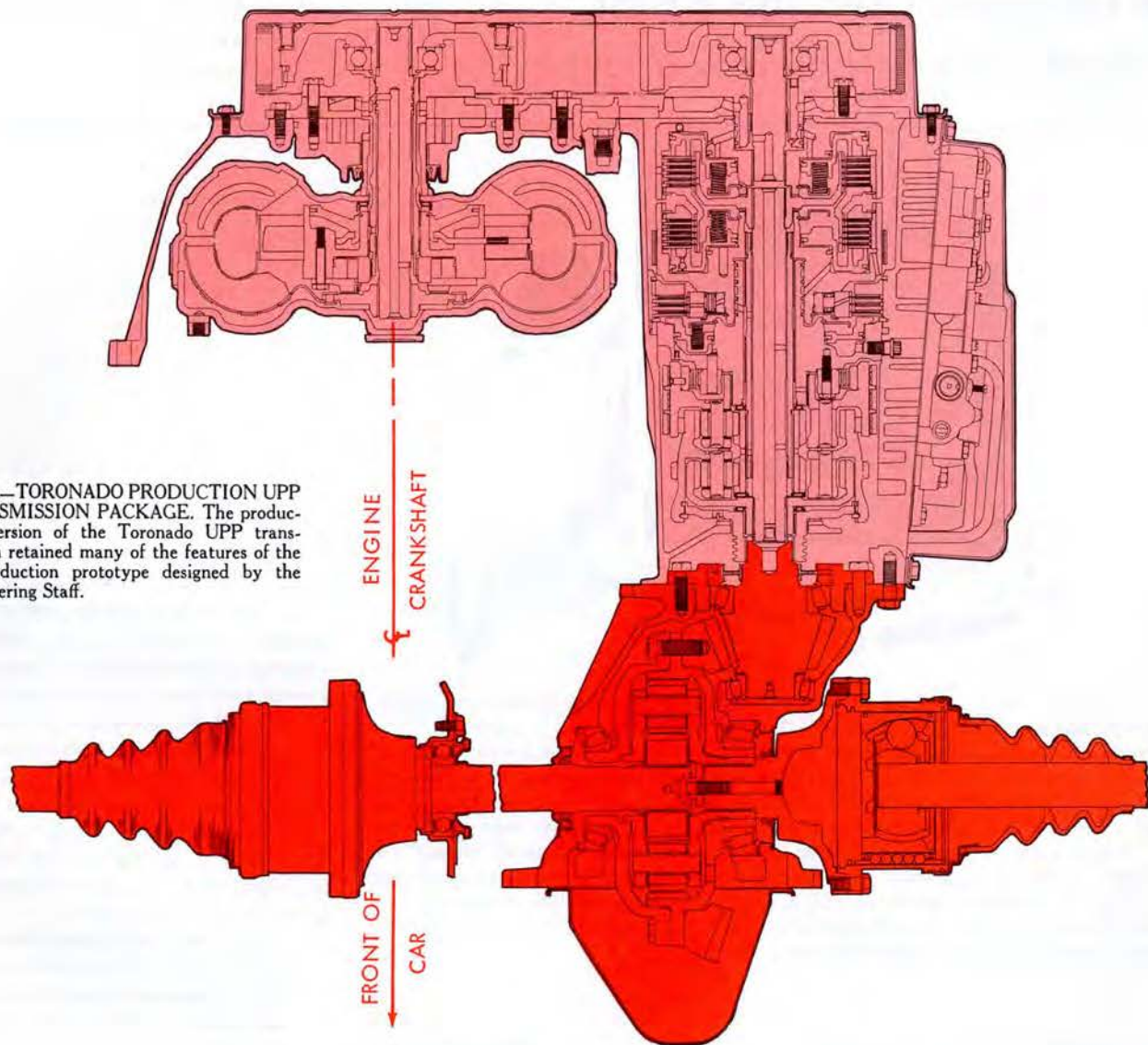

Fig. 10—TORONADO PRODUCTION UPP TRANSMISSION PACKAGE. The production version of the Toronado UPP transmission retained many of the features of the pre-production prototype designed by the Engineering Staff.

of full and part throttle accelerations, high speed braking, climbing 7 and 11 per cent grades, and selected manual transmission shifting over a prescribed road pattern of hills and turns. Actual road records of throttle position, wheel speeds, brake application, and transmission gear selector position were made in a car running on this Schedule. This information was programmed into the dynamometer control system to accurately simulate these conditions. The test unit included a complete UPP—engine, transmission, final drive, and axle assembly—coupled to two eddy current braking dynamometers to simulate grade and road loads, each in series with flywheels

of equivalent car inertia.

A unit was sent to Oldsmobile Division for their test and evaluation. The results of these tests indicated that this type of unit was suitable for consideration for a production vehicle. Concentrated effort was now placed on the production aspects of the design. Due to the scope of the operation, the amount of test and development work still to be done, and the time schedule proposed, responsibility for various design areas was divided among several production Divisions to arrive at a suitable production design. The physical arrangement of the production design (Fig. 10) was basically the same as the experimental unit, but some

parts were revised for more economical manufacture.

Conclusion

After almost 10 years of extensive developmental work, the first successful unitized power package front wheel drive unit became a reality. The UPP concept offers almost unlimited potential for future applications. Successful European front wheel drive cars have been marketed, but this is the first UPP front drive concept with an automatic transmission. The automatic transmission has made front drive practical in larger cars by eliminating former critical problems associated with this type of drive.



Structure and Suspension Development for the Front Wheel Drive Vehicle Concept

By LAWRENCE J. KEHOE, JR.
and FRANK A. SHERWOOD
General Motors
Engineering Staff

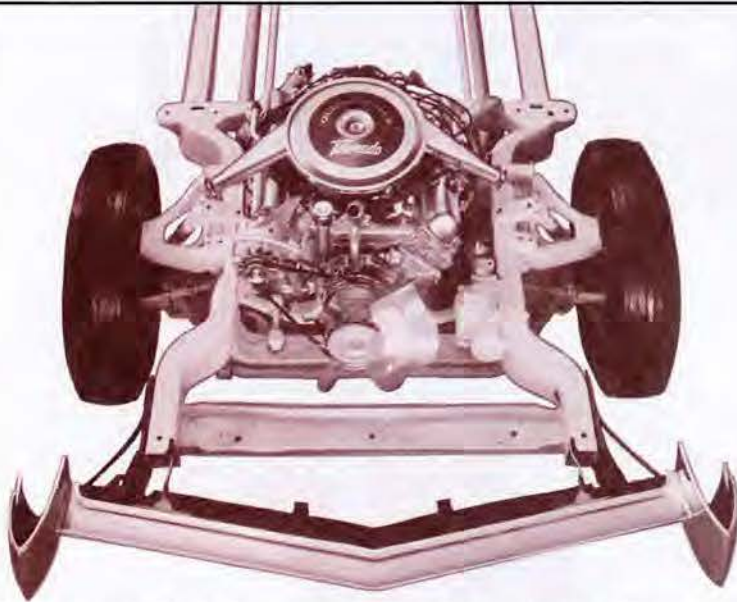

Front drive concept
permits body design
innovations

The GM Engineering Staff's Structure and Suspension Development Group is responsible for design and test work on both car structures and suspensions because of the common problems involved in these two areas. Extensive engineering studies are conducted on chassis and suspension designs to explore new and re-evaluate old ideas in an effort to develop new concepts for present and future automobiles. The Group concentrates on studies, tests, and developmental work on mechanisms designed to steer cars more positively and to make handling even safer under today's road conditions. In conjunction with these programs, work also is done on shock absorber control, engine mounting, and car weight distribution. Structure and suspension development was conducted concurrently with the work of other Groups at the Engineering Staff during the unitized power package (UPP) front wheel drive program.

THE engineering development Groups at GM Engineering Staff are responsible for being fully conversant with the state of the art in their respective fields. The Structure and Suspension Development Group, for example, evaluates many cars which have new or novel features. European front wheel drive cars were evaluated as they became available, and some were purchased for more thorough examination. Along with this interest in current production cars, design studies were made from time to time for possible front wheel drive configurations. These outline studies were handled as design exercises, usually with no intention of building a particular suspension system. However, while data were available on low performance vehicles, operating data were lacking for high performance front wheel drive

cars with respect to handling, noise transfer, behavior in turns, tire life, and the effect of weight distribution on performance and hill climbing ability. All these items eventually would influence a decision to design a production UPP vehicle.

Specific Design Studies Begun

At the same time that front wheel drive concepts were being studied by the Structure and Suspension Group, the Power Development and the Transmission Development Groups of the GM Engineering Staff had been conducting feasibility studies of their own. The various Group heads had discussed their ideas on what might be done in a large front wheel drive vehicle with the vice president in charge of the GM Engineering Staff.

Each Group proposed the design features in its area of responsibility which were believed to be the best to use. After the proposals originating in each Group were reviewed and narrowed down, basic decisions on the overall vehicle design were made. Final design of the components was in the hands of the responsible development Group.

Based on experience, Structure and Suspension Group engineers felt that the following features would be appropriate in a front wheel drive car:

- Engine and independent front suspension mounted to a sub-frame
- Unit construction body to which the sub-frame would be mounted through insulators
- A simple type of rear suspension
- A low, flat floor in the body.

Sub-Frame

The engine, transmission, and drive train would be mounted on a sub-frame, which would carry the front suspension. By unbolting the sub-frame, all the vehicle drive components could be removed as a unit, which would facilitate service or repairs.

The front spring design that evolved used torsion bars, with which the Engineering Staff has had considerable experience. The first torsion bar design in the early 1930's was used on the Vauxhall car and was called the TT (Torsion Tube) suspension. In 1942 a suspension was designed for the first American tank using torsion bars, the T20. This suspension

subsequently was scaled up and used on the M26 and other tanks.

Shortly after World War II, Structure and Suspension had its first experience with what might be referred to as a front drive vehicle. This involved designing and installing a new front wheel drive torsion bar suspension on a pair of military six-by-six trucks. This was the start of a close association between Engineering Staff and Saginaw Steering Gear Division. Saginaw supplied the constant velocity universal joints which were used for the front wheel drive on the trucks.

In 1952, to obtain further experience, a very satisfactory torsion bar front suspension was designed and built using a prototype 1955 model automobile. Laboratory testing of the components for this vehicle confirmed the belief that with realistic stress parameters, the major problem was not with the bars themselves, but with the anchors. Properly designed anchors eliminated the high stress area at the point of initial contact between the torsion bar and the anchor.

At this time, also, coil springs did not lend themselves to inclusion in the sub-frame concept because of the difficulty in transferring wheel load reactions through a sub-frame. The first design approach used conventional torsion bars, placing the rear anchors back near the transverse cross member of the car. However, this led to an interference problem; with a conventional torsion bar the rear anchor would need to be located approximately at the front seat point. Since the new design would lower the floor and move the toe board forward for increased driver leg room, no space was available for the rear of the torsion bar or for the anchor mounting. A different design approach was necessary.

A few years before this, the Group had developed a new torsion bar that required an overall length only about one-half that of a conventional torsion bar. The problem of high unit stress at the anchor contact point had been solved, and a number of experimental cars were built which performed satisfactorily. With the short overall length of this torsion bar, it was possible to attach the rear anchors ahead of the dash to the engine suspension sub-frame.

Simple Rear Suspension

From the start, Structure and Suspension recognized that the addition of two constant velocity universal joints, plus



Fig. 1—DYNAMIC STEERING TEST INSTRUMENTATION. Multiple needle recording and plotting instruments (top) mounted in the rear seat of the test car were used in the dynamic testing of front suspension components (bottom). Wheel angularity and joint forces were measured in tests of this type.

two normal Cardan joints, together with more complicated front knuckle supports and stouter front suspension arms, would increase the cost of the front suspension over that used on a normal rear drive car. This was offset, however, by the elimination of the propeller shaft and its two universal joints, and the use of a simple beam type rear axle and Hotchkiss single-leaf springs. Many years of developmental experience had been gained with single-leaf springs, which were introduced on the Chevy II in 1962.

One of the difficulties previously associated with single-leaf spring design was the lack of any formulas that would permit the design of its free shape. This free

shape—that is, the shape of the spring before it is installed—is important because it determines the standing height of the vehicle and the curvature of the spring under load. Since the spring undergoes considerable deformation as it deflects from its free position to its design position, the calculations involve large deflection theory. No algebraic formulas are available for large deflection problems except for a few limited cases. Also, the semi-empirical methods developed through the years for multi-leaf springs are not applicable to the design of single-leaf blades. For these reasons a new approach was needed to determine the free shape of a single-leaf spring.

The solution turned out to be surprisingly simple and was based on the assumption that the blade could be imagined as being comprised of a series of connected beams. By dividing the blade into enough sections the deflection of each elemental beam could be reduced to a point where the standard small deflection formulas were valid. Then, by connecting the individually deformed sections into their correct geometrical relationship, the required free shape curvature could be laid out.

A complete solution to determining the free shape curvature started with the preliminary step of treating the spring as two cantilevers fixed to the axle, as indicated in the following diagram.

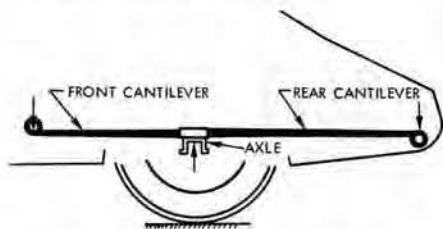

The free shape and design position centerlines for one of the cantilevers were indicated as follows.

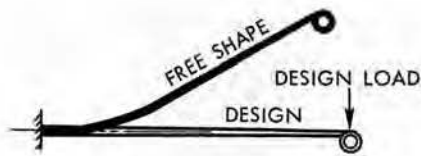

The centerline at the design position was shown flat for simplicity. (By modifying the method slightly, the design curvature could have any prescribed shape.)

The next step was to section the blade until the length of each element was about 1/30 of the total length, as shown below.

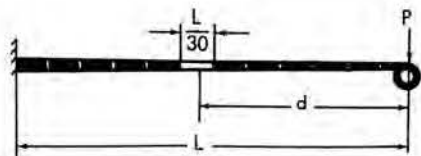

With the flat spring in its design position, the bending moment was calculated at the center of each beam. Since this would be the bending moment that would deform the free curvature of each element until it became flat, it followed that the curvature of the free shape would be equal and opposite to the change in curv-

ature produced by the design position's moment. The following equation:

$$R = \frac{EI}{Pd}$$

where

- R = radius of curvature
- E = modulus of elasticity
- I = moment of inertia
- P = design load
- d = moment arm

was used to relate the bending moment to change in curvature. Although the bending moment and moment of inertia varied along the element they were considered to be constant and equal to the average values computed at the center of the element. By taking enough sections the length of each element could be made short enough to keep this error within acceptable limits.

After the radius of curvature had been computed for each beam, the free shape was laid out as shown in the following diagram.

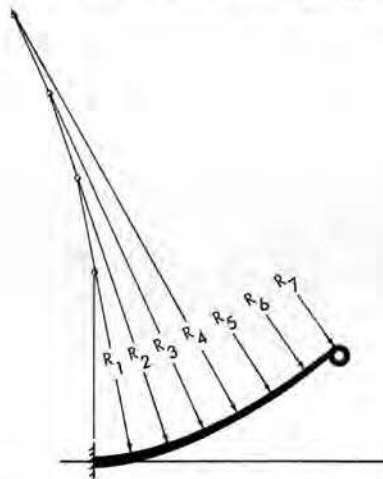

The arcs were drawn tangent to each other at their points of intersection. Because the radii were frequently quite long, it usually was more practical to compute the location of the points of tangency, then draw the curve from the coordinates.

Accurate results required a spring to be divided into approximately 60 sections. Although the calculations were not difficult, they were time consuming and tedious. For these reasons, a program was written for a digital computer which, of course, is ideally suited to making simple, repetitive type calculations. The innovation of this method coupled with the advantages of using a computer proved to be an invaluable aid.

Flat Floor

Since the transmission was to be contained in the engine compartment, there would be no need for propeller shaft clearance and the entire passenger compartment floor could be reworked, eliminating both transmission hump and drive line tunnel. This body configuration lent itself well to the unit construction concept for which Structure and Suspension Development Group had accumulated over the years a good base line of desirable values in both beaming and torsional modes. When the completed body was tested in the laboratory, the stress calculations proved the design to be within the desired values.

Final Design Developed

By mid-June of 1960, the first car was ready to drive and the development and demonstration program was begun. This work consisted mainly of picking up and improving details. Most of the time was spent in improving the ride, handling, and overall operating characteristics of the experimental car relative to the production car. This front drive car proved to be stable, lacked harshness, and handled well. In normal driving, the UPP car's handling was not noticeably different from that of the conventional car. However, an improvement in stability at speed and in cross winds was quite noticeable.

In addition to the usual subjective evaluation of the vehicle's properties, considerable time and effort were devoted to instrumentation (Fig. 1) to obtain quantitative measurements of the car's performance. For example, hill climbing ability was outstanding. Also, during this time tread depth was being monitored on the tires of both the UPP car and the comparison car, with the final results indicating that tire wear would not be a problem.

Periodically, the car was demonstrated to interested chassis people from the Divisions so that they might keep up to date with the progress of this study. Later, a decision was made to convert two cars to accept a 429-cu in. V-8 engine. This was accomplished and the engine was accompanied by a new transmission design.

At this stage, there was sufficient interest to decide that another generation of developmental UPP cars should be built, concentrating the design on a two-door coupe which would contain the latest thinking of the Styling Staff, Fisher Body Division, Manufacturing Staff, and

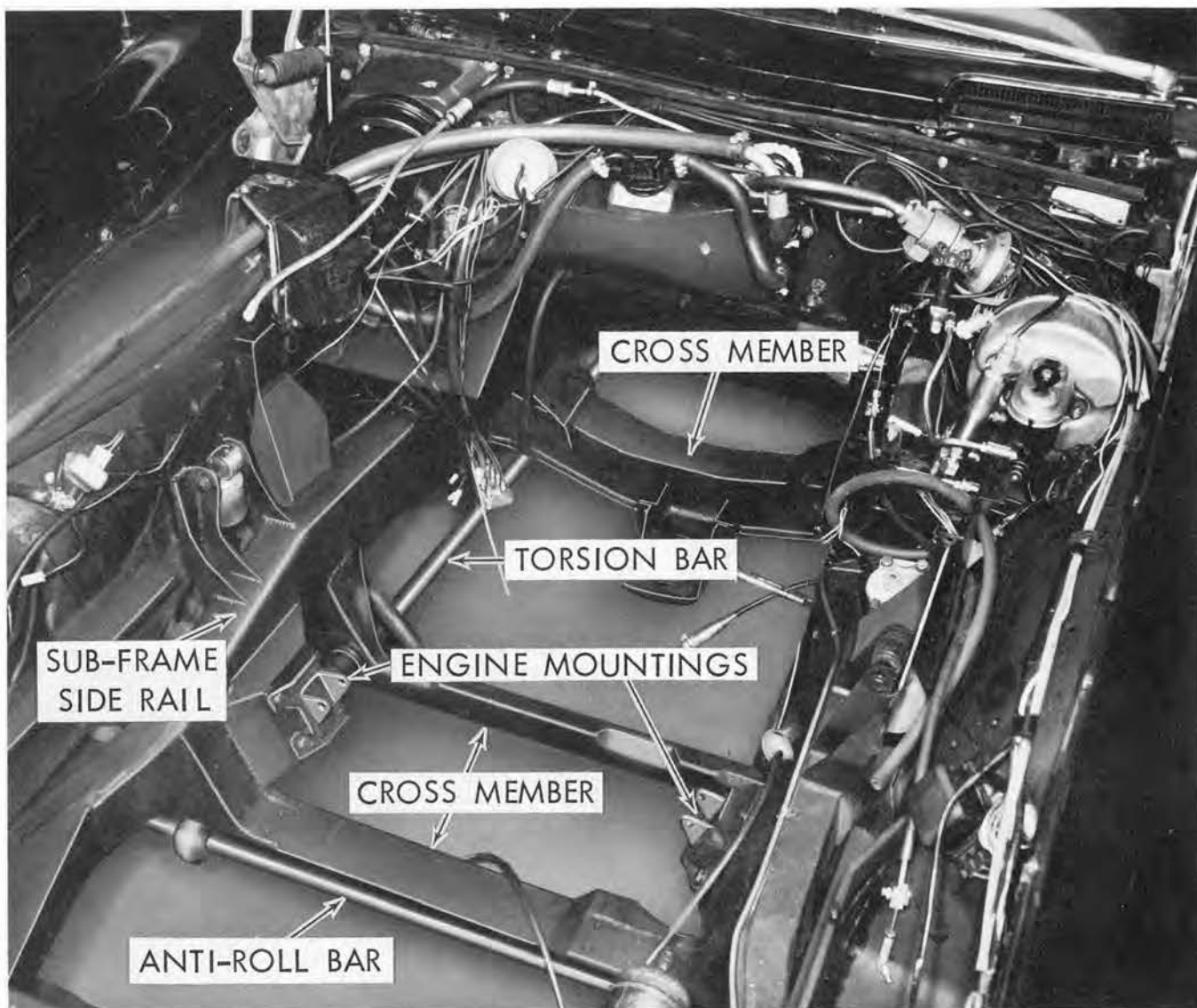

Fig. 2—DEVELOPMENTAL SUB-FRAME. Shown here is the sub-frame designed by the Structure and Suspension Development Group to support the power package and front suspension on the last generation of UPP vehicles developed by the Engineering Staff.

Engineering Staff. In this way the final vehicle would come very close to being the design for a product which would have desirable contours, make efficient use of materials, be feasible to build, and have the required performance, handling, and comfort. This development also would be of assistance to Oldsmobile in the work well under way on the development of a full-size front drive car.

Representatives of the Staffs and Divisions reviewed proposals and counter proposals on every phase of the car. It was agreed that the cars would have a 429-cu in. V-8 engine, a three-speed torque converter, and front suspension similar to the previous design. The power package and front suspension would be

mounted on a sub-frame (Fig. 2). The bodies and sheet metal would be based on an existing body that most closely approached the package size required.

Fisher Body delivered the reworked bodies complete with seats and trim in mid-1963, built to production standards. These were running and under development in a month's time, since chassis component development had started at the same time that Fisher Body had begun converting the bodies.

Various refinements were worked out during the developmental stage. As an example, the type of rubber mounting between the frame and body was found to have a major influence on the ride, noise, and shake characteristics of the

vehicle. Mountings could be developed for tension, compression, or shear, but the type which improved one condition more often than not affected the other two. Developing the best combination required subjective evaluation of many proposals before a satisfactory solution was found.

Conclusion

Demonstrations with these cars were a factor in the decision to produce a front wheel drive car. The results of the work on Engineering Staff UPP vehicles helped show that such a drive concept was feasible. It also pointed out body design innovations which would be possible due to the location of all drive components at the front end of the vehicle.

AUTOMOBILE design is a business at General Motors Styling, but its aesthetic nature makes it an adventure, too. For those who participated in the Oldsmobile Toronado design it was probably their most challenging adventure, and one that does not occur often. The Toronado project with front wheel drive and the resultant low flat floor opened entirely new possibilities for vehicle architecture and provided the opportunity for Styling designers and engineers to come up

with a completely fresh design approach. GM Styling firmly believes that one of the greatest sources of inspiration to automobile designers is engineering innovation. They regard inspired designs as the best designs—ones that move fast from the original concept to the conclusion. And that's the way the Toronado program went.

Advance Concept Work

Prime sources of new ideas at GM Styl-

ing are the Automotive Research and Advanced Design Studios which probe far into the future and freely experiment with novel concepts. The results of such advanced studies ultimately spread through the creative atmosphere at Styling to become design directions that shape and influence the approach to design for production. This design experimentation follows two approaches. The first emphasizes development of new architecture that leads to different vehicle shapes. The

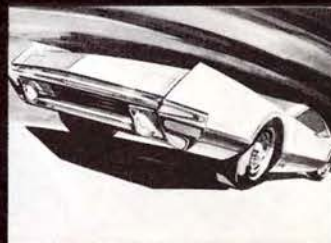

The Toronado Takes Shape

By WILLIAM L. MITCHELL
Vice President in Charge
of GM Styling Staff



second approach is to explore unconventional shapes that then spawn new vehicle architecture.

Years before the front wheel drive program officially began at Oldsmobile, Styling, in cooperation with various GM Divisions and Technical Center Staffs, conducted a comprehensive study of front wheel drive to be fully familiar with the unique characteristics of this type of vehicle architecture when the proper time came. Various front wheel drive studies

underway at the GM Engineering Staff, for example, were important to this effort. The eventual Toronado design theme, however, originated with a flame-red illustration of a low, four-passenger car. This full-size airbrush rendering was completed by GM Styling as a possible design direction for a new Oldsmobile character and image. Unknown at the time was the fact that it would actually become the design theme for an extraordinary production car.

Studio Design

In early 1962 the Oldsmobile Studio design team at GM Styling was busy putting finishing touches on the 1964 model Oldsmobiles. While this work was being completed, the designers were presented with a challenge to apply their creative efforts to the design of a dream car that they themselves would like to own and drive. Every Studio member shared in the project and welcomed the challenge of portraying a fresh approach

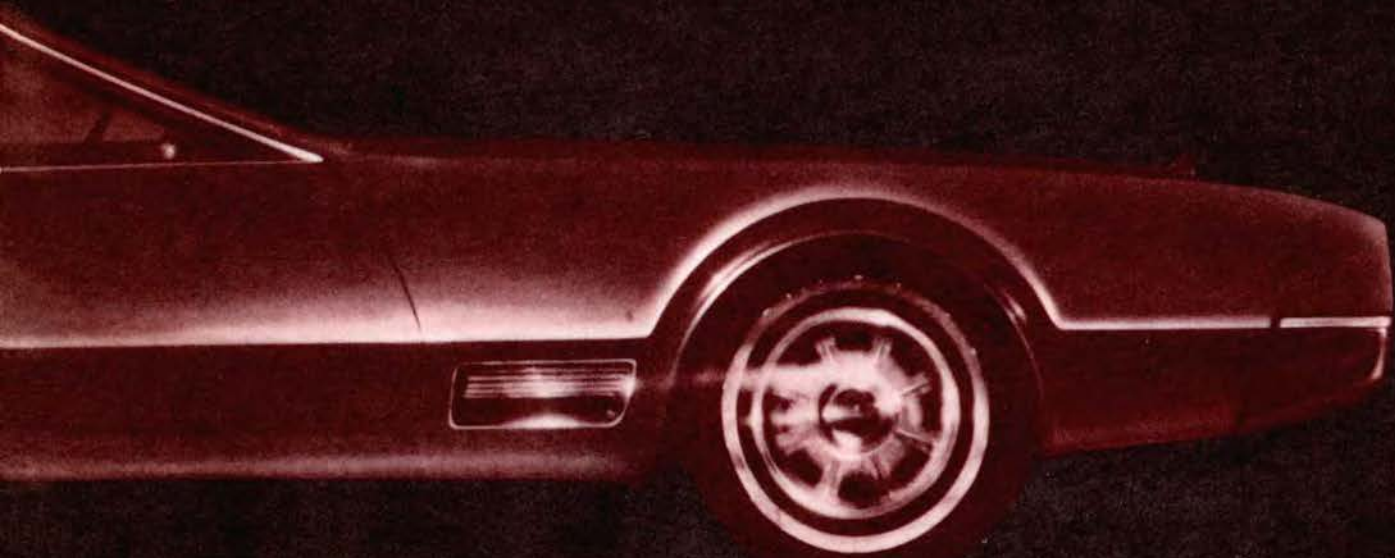
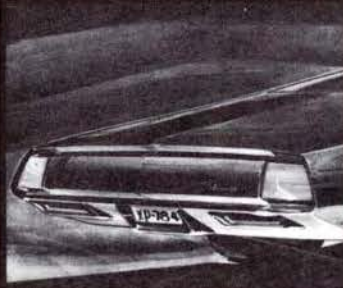

to a sophisticated sports type car. It was to be a car in keeping with Oldsmobile's character and engineering quality and was to have functional lines, a long hood, chopped deck, and other distinguishing marks of a sporty automobile. The design ideas were compatible with each other and close to what became the ultimate design. All of the ideas were incorporated in the original flame-red illustration, which immediately won the unanimous admiration of those members of Styling management authorized to see it. So that

the design could be explored in three dimensions, Styling's Advanced Design Studio No. 3 was assigned to develop a full-size clay model. In this Studio, the work could be carried out in complete secrecy under supervision of Oldsmobile designers, but isolated from other production design activities.

Engineering Layout

In the summer of 1962, Oldsmobile Division independently decided to initiate a formal production program for a full-

size front wheel drive car and sent engineering specifications of their prototype to Styling.

The thoughts of everyone concerned turned immediately to the flame-red illustration and the developing clay model based on it. The design seemed ideally suited to the concepts established by Oldsmobile for its new car.

Early in the fall of 1962 full-size drawings of the front wheel drive car's total architecture were prepared at Styling. Mechanical requirements were checked

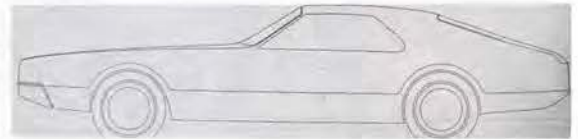
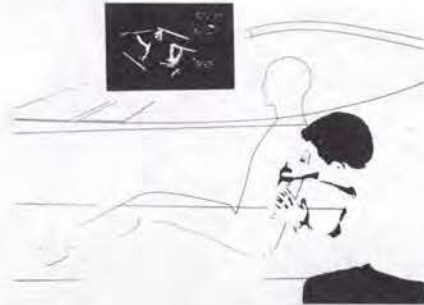

STUDIO FULL-SIZE LAYOUT DRAWING

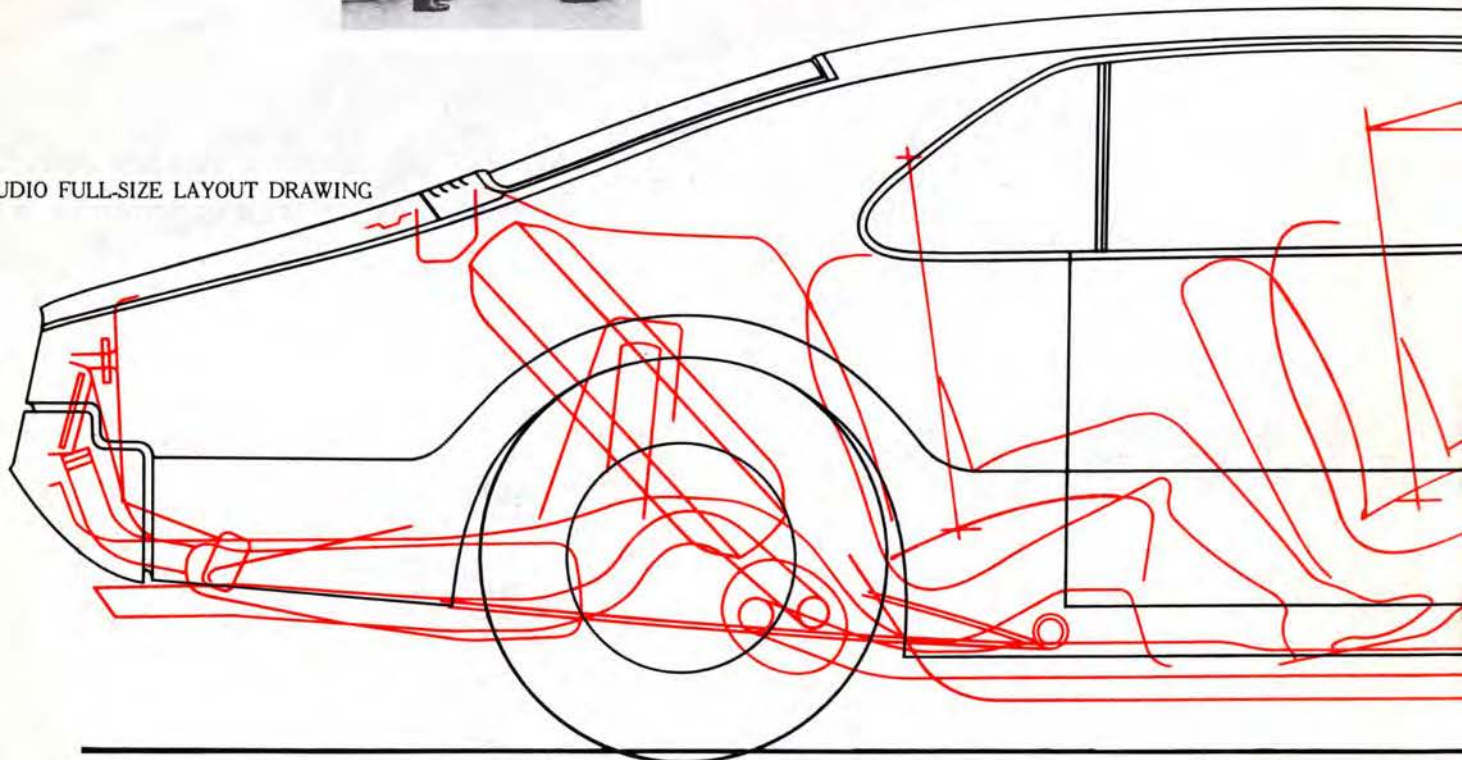

in detail as were safety considerations. At the same time, Styling's Body Development Studio considered the many human accommodation standards for persons of different physical builds. These were carefully analyzed with close attention to such matters as proper headroom, leg room, reach to wheel, pedals and instrument panel controls, and entrance and exit conditions. When the interior conditions were established, the clay model was revised to correspond. Next, seating mock-ups were built for a more accurate physi-

cal check of promising paper layout arrangements. As the clay model progressed, the dimensions of the car were evaluated against other sports and prestige models, both American and foreign-made. The project was exhilarating to designers and engineers alike because the front wheel drive architecture offered design proportions rarely experienced. The seating advantages afforded by front wheel drive were obvious. With no space intrusion for driveline components, the usual raised tunnel was eliminated. The

immediate result of the flat floor was more room and comfort. Also, by eliminating the usual rear axle and differential more space was available for trunk volume. Thus, without any reduction of luggage capacity, a shorter rear overhang was achieved. This gave the Toronado its distinctive silhouette that plainly indicated its front wheel drive character.

Detailed Clay Modeling and Management Review

Sketches and renderings are useful in

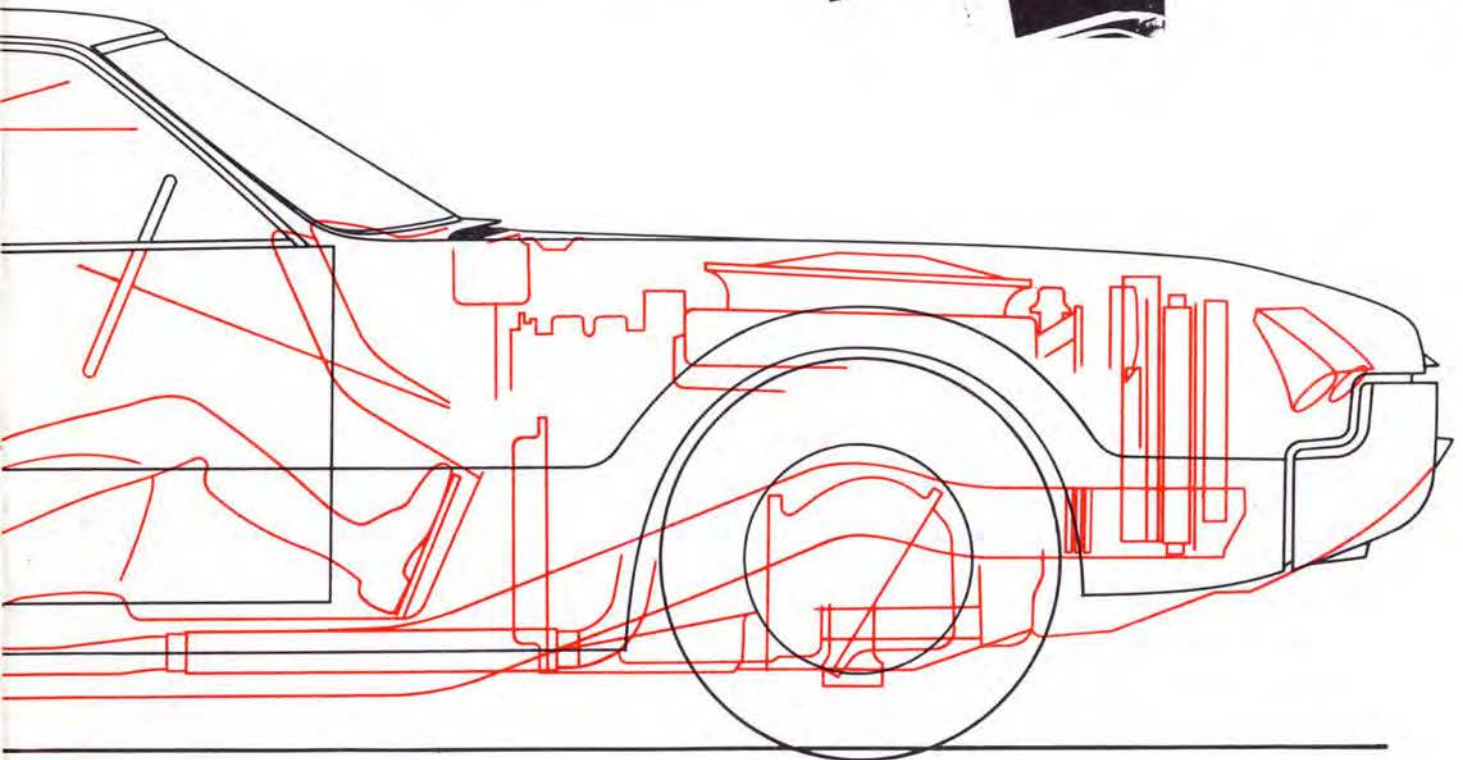

the early stages of working out basic themes and design directions. The real test, however, comes when an idea emerges in a solid, three-dimensional, full-size form. Many advanced ideas look good on paper, but may prove ungainly in the larger three-dimensional form where every surface detail and highlight is seen in its true perspective.

Modeling in pliable clay permits changes to be incorporated easily so everything

from a slight contour modification to an entire new front end can be accomplished quickly. Skilled sculptors shape the clay material to an accuracy within one one-hundredth of an inch. Then, the full-size clay model is prepared to appear much like an actual automobile with the addition of real wheels and tires and detail hardware items, such as door handles and headlights. Glass areas are simulated by a covering of plastic sheets or a coat of

paint, while metal foil is applied to other areas to resemble chrome and bright work. Occasionally, colored sheets of flexible plastic are applied over the clay to give an indication of paint highlights on surface shapes.

As the work of refining the Toronado design in clay progressed, it was reviewed frequently by Styling management who evaluated every aspect. The first showing of the Toronado clay model was outdoors

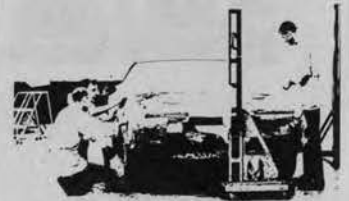

FULL-SIZE CLAY MODEL



in February 1963, when the clay model was well along and the project reached a stage where Oldsmobile and Corporation management approval was indicated.

Styling has a special indoor viewing auditorium for bad weather use. When weather permits, however, most showings are outdoors since the light is better and a natural environment is preferred. To avoid guesswork in making crucial decisions, great care is taken so that models are

shown under those conditions in which the car eventually will be seen, sold, and used.

The first reaction to the Toronado was enthusiastic and produced general approval of the basic design. Nevertheless, Styling continued to look for ways to improve the car's appearance. For example, during the refinement process, the Toronado's belt line was lowered to obtain better proportion, and the rear deck was lengthened to improve the over-

all profile. Also, the roof line was raised slightly to adjust to new seating requirements. Another change was to increase wheel diameter to give more emphasis to the wheels.

With the basic directions fairly established, a 1/4-scale model was fabricated and equipped for a series of wind tunnel tests to check aerodynamic qualities of the body design. Information from previous aerodynamic studies influenced the

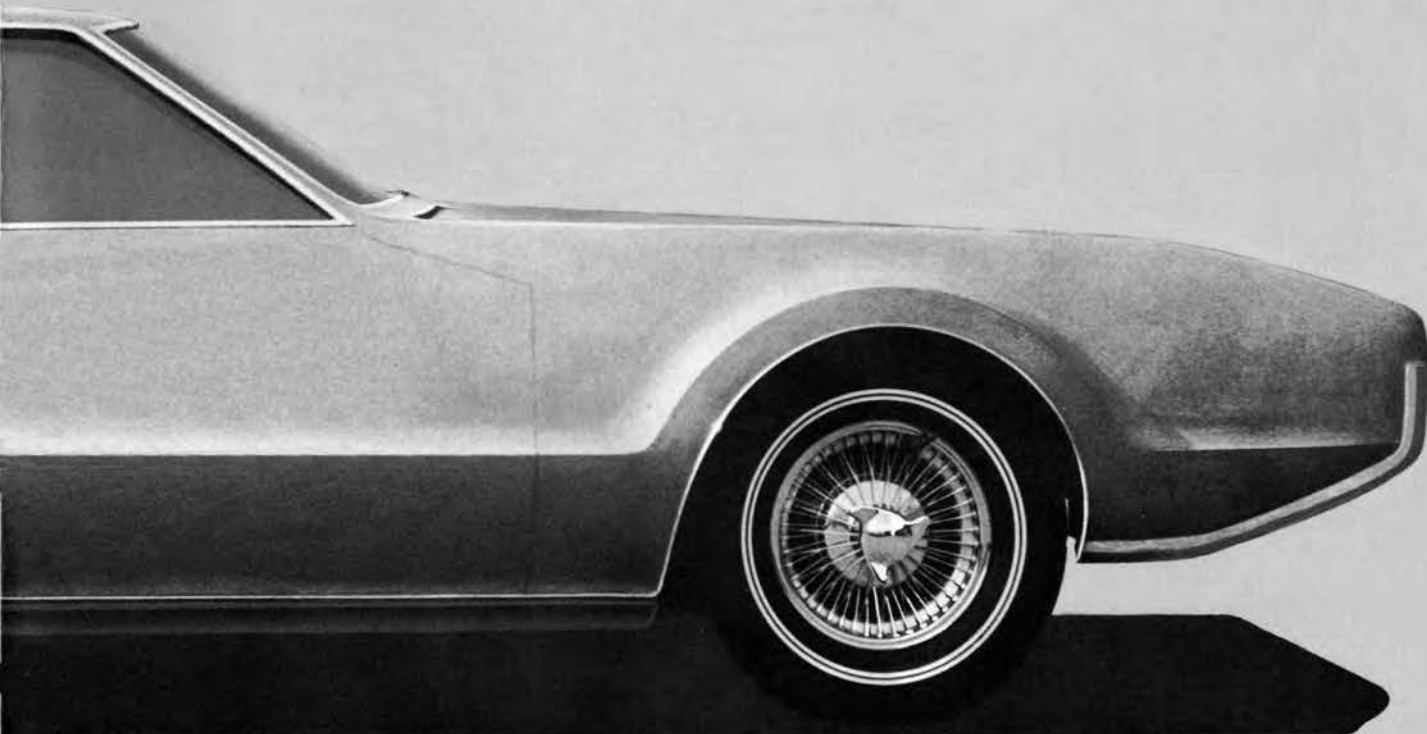

Toronado designers to propose elimination of the front vent windows. This had an effect of reducing wind noise, enhancing visual appearance, and improving driver vision. Modelers worked alongside Styling's aerodynamicists to rework models right in the wind tunnel so indicated changes could be tried and evaluated on the spot.

Interior Design

Design of the Toronado interior began

in the spring of 1963 in the Oldsmobile Interior Design Studio at GM Styling. The interior designers wanted to achieve a sculptured feeling of unity among all interior elements, with each surface blending smoothly into every adjacent one. Many new approaches and concepts were considered in search of a safe, elegant, advanced-style interior that provided complete design integration with the overall theme. A new "driver podium" instrument panel was conceived

as one version for the new Toronado concept. Miniaturized instrumentation and an electronic, vertically revolving speedometer also were proposed. By January 1964, the interior concept was modeled in clay, shown, and tentatively approved. Various tests, including ventilation tests performed at the Proving Ground's Mesa, Arizona, facility led to changes in instrument panel design. A decision to use air conditioning duct outlets as part of the regular ventilation



FULL-SIZE SEATING MOCK-UP

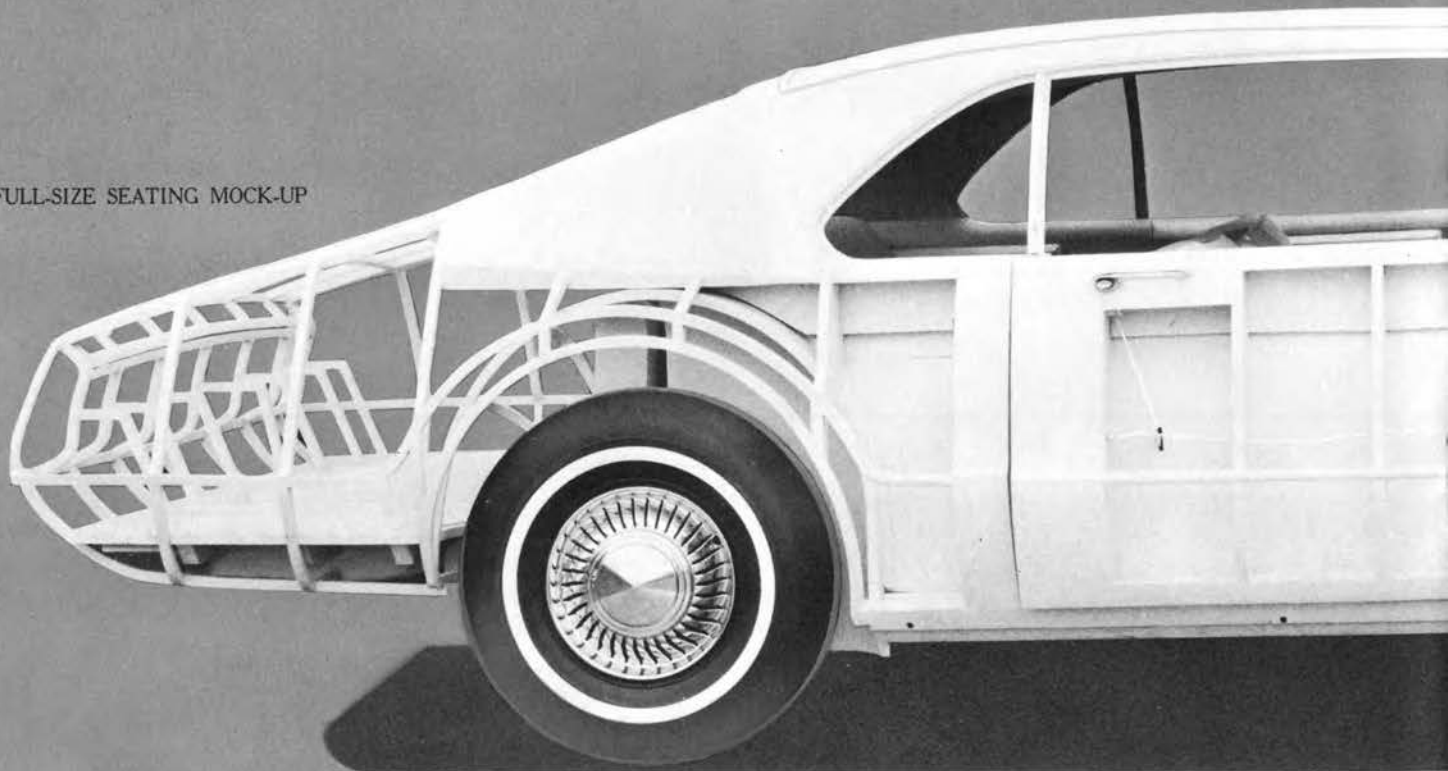

system caused still more instrument panel design revisions.

Final Clay Modeling

As work continued in both the Oldsmobile interior and exterior design studios, the full-size clay model was continuously revised to reflect the latest changes, while working out and refining the many styling details affected by various engineering modifications. Another thorough review of the final clay model produced

additional design and engineering changes. When the clay model was next reviewed by management and given approval at that stage, casting in plaster was ordered.

Glass Fiber Design Model

Once the plaster casts were ready they were used by Styling's fabrication shops as molds to make glass fiber panels. These rigid panels are mounted on a dummy chassis with special frames and can be painted, chrome plated, and made to

appear real in every detail. Styling's craftsmen take great care to make near-perfect prototype replicas for management's evaluation, because authenticity is absolutely vital prior to any decision to go ahead on a new car program. The first glass fiber model was ready for review by management in July 1963. It was an exterior-only model. Work then began on an updated model complete with interior and all hardware fittings. In early summer of 1964 this model, painted and

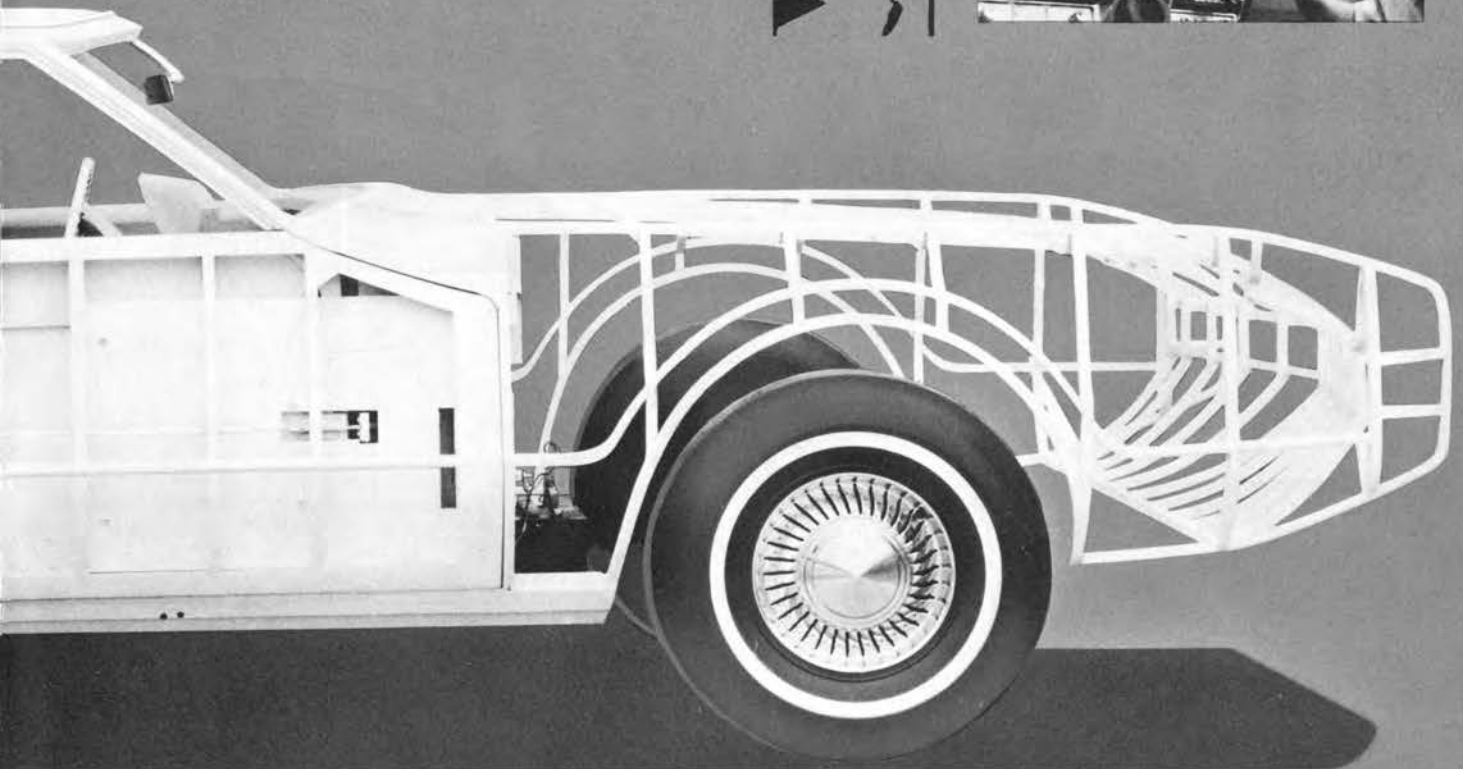
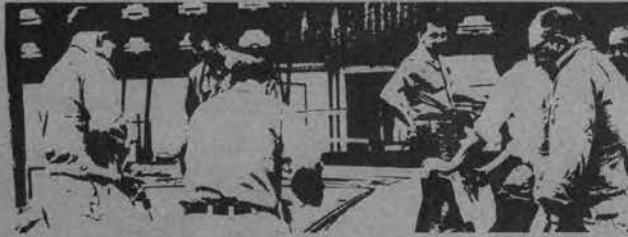

trimmed inside and out, was ready for review by the General Motors Board of Directors. This was approximately one year in advance of the time the Toronado would go into volume production.

*Finished Model
and Other Business*

After the Board of Directors showing some minor changes and improvements

were made until the last possible minute. One such change, for example, saw the Toronado's tail lights redesigned to provide a more refined appearance.

Styling and Oldsmobile management decided it would befit the Toronado's unique characteristics to have special, unusual exterior colors with matching interior trim. Several colors were chosen and developed exclusively for this pur-

pose. Naming of the car was another challenge to Corporation, Divisional, Styling, and advertising agency representatives. Everyone agreed the name must suit the particular character and image of the car. Hundreds of names were considered before the word "Toronado" was selected. The name has no actual translation, but its distinctive sound well fits the image envisioned for the car.



FULL-SIZE STYLING
PROTOTYPE MODEL

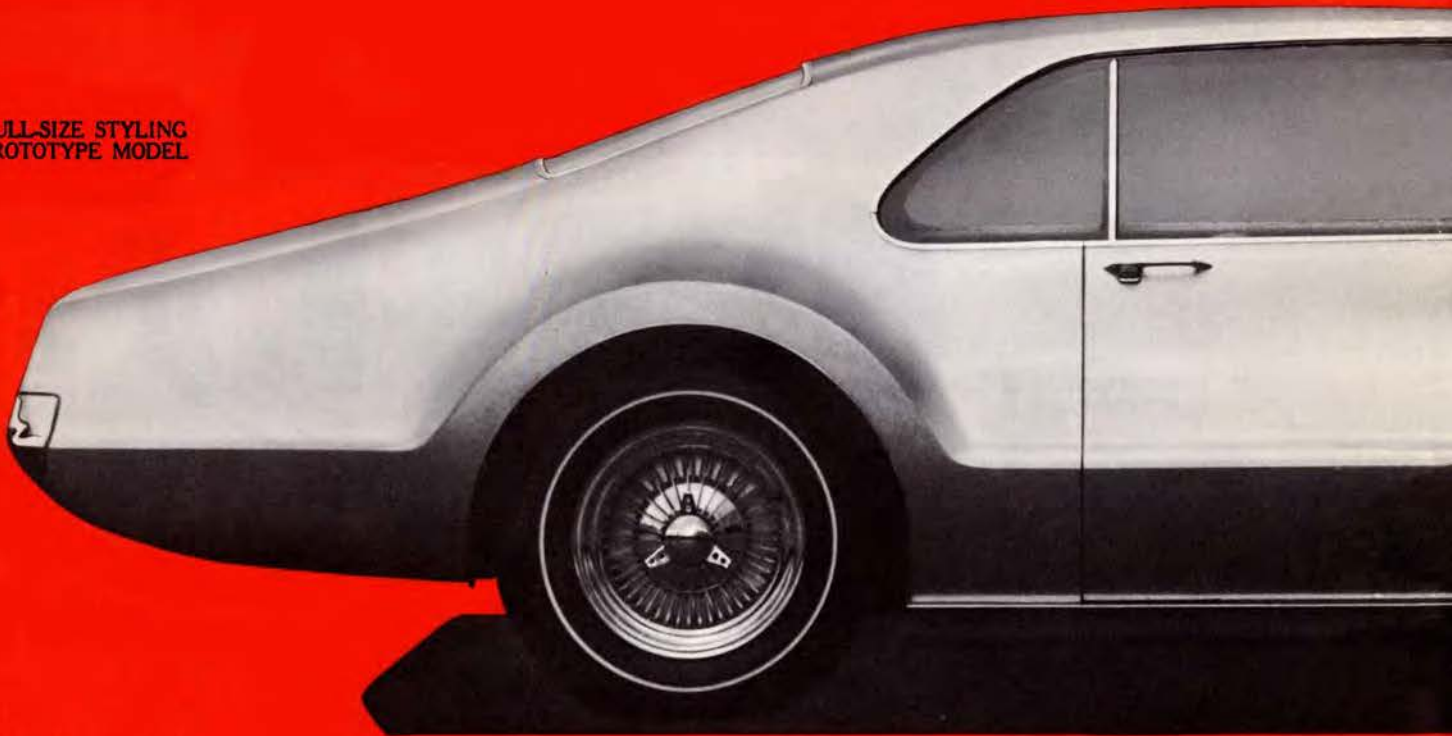

Conclusion

Automobile stylists no longer merely decorate a virtually complete engineering design as in earlier years. Today, designing an automobile is as technical as it is artistic, although aesthetics still is the magic potion that transforms lifeless, technical data into good-looking, eye-appealing designs. Apart from its other features, the Toronado is especially sig-

nificant as an example that the shape of automobiles grows out of their structure and function. It signifies that tomorrow's automobile is deeply rooted in technological advancements. Consequently, to achieve the total unity necessary to spark automotive innovation and progress, collaboration between engineers and designers will become even greater in the years and cars ahead.

Toronado

BY OLDSMOBILE

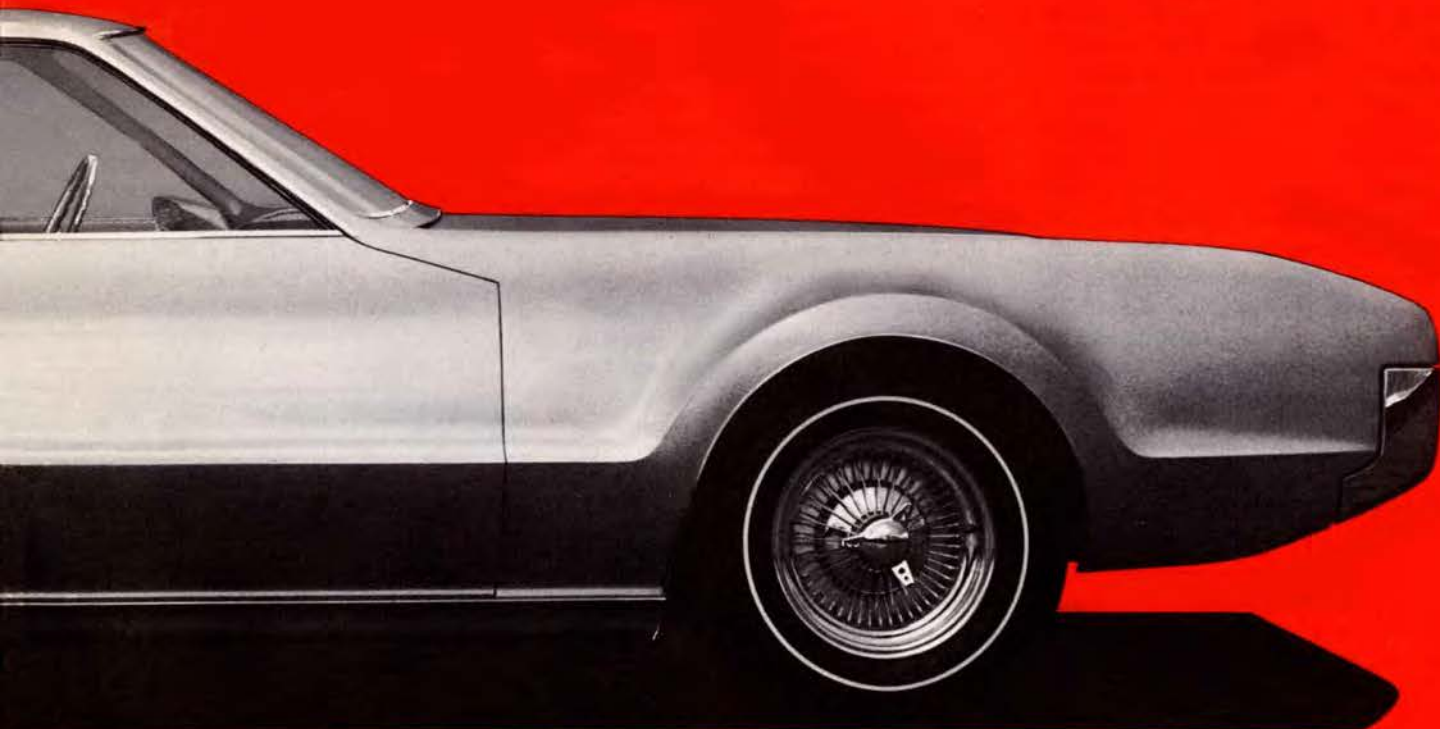

Development of a Body Ventilation System

The Vehicle Development Group of the General Motors Engineering Staff designs, builds, and tests complete experimental vehicles to appraise the basic engineering aspects of new developments. Investigations may be concerned with such features as unique body construction, chassis design, ventilation systems, and related components. Early in 1963 the Vehicle Development Group began a project to develop a ventilation system for the UPP vehicle. The Group developed a prototype system which operated with all car windows closed and eliminated the vent windows. This system design provided Fisher Body and Oldsmobile Divisions with valuable experience in the development of the ventilation system for the 1966 Oldsmobile Toronado.

VENTILATION was not a problem in the early days of the automobile. Most early automobiles had open bodies—bodies in which the passenger compartment was not fully protected from the weather. A few incorporated canvas tops for partial protection. With the advent of fully enclosed car bodies around 1920, motorists became aware of the need for adequate ventilation. By opening a window, a person could increase ventilation but exposed himself to air buffeting and the noise associated with open car windows.

In 1933, Fisher Body Division introduced Individually Controlled Ventilators (CV windows) on their automobile bodies. These ventilators were located to the rear of the windshield pillars and a few years later were supplemented on some models by CV windows in the rear passenger compartment. The CV windows allowed fresh outside air to be scooped into the car and exhausted stale air from the passenger compartment. The CV windows improved the performance of car ventilation systems and through the years various design changes were made to increase their effectiveness.

Ventilation System Project Begun

Some time ago the GM Engineering Staff's Vehicle Development Group started a project to develop an automotive ventilation system that would be operable with all windows closed and would eliminate the need for CV windows. The system was to be a prototype for the 1966 E* body.

*The letter E is simply a code designation for a particular body shell configuration.

Previous ventilation work done by Fisher Body, Styling Staff, and the car Divisions was investigated to learn how well other experimental systems had functioned for possible application to the 1966 E body car. To gain more information on car ventilation and various means of attaining an adequate system, competitive U.S. and foreign cars equipped with auxiliary vent provisions were road tested. All these cars had CV windows in addition to some form of air extractor. Certain inadequacies of these systems aided in formulating what might be more desirable in the proposed system.

After consideration of these tests and discussion with Oldsmobile, Buick, Styling, and Fisher personnel, some objectives of the new ventilation system were established. The system should provide a quiet, comfortable passenger environment constantly furnished with outside air. It should provide enough air at a velocity sufficient to fully ventilate all critical levels of the passenger compartment. At the same time, air velocity should be low enough so that air flow noises and drafts would not be objectionable to the occupants. This was called the *high quality-low velocity* concept. The system should operate under all weather conditions and represent a labor and maintenance savings compared to previous systems. A program then was outlined which included testing with instrumentation and more importantly with people who, hopefully, would represent a cross section of potential customers. The final judge of any ventilation system, of course, would be the customer.

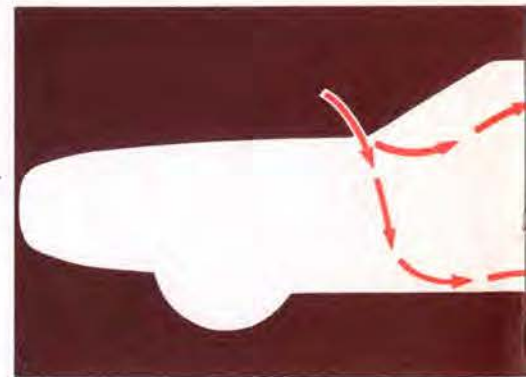

Wind Tunnel Tests Aid Evaluation

To design a ventilation system properly, knowledge of the air flow characteristics on the exterior of the particular car under consideration is essential. The design of effective air intakes and extractors depends on these air flow characteristics. As a car moves through the air, the air offers resistance to car motion and tends to pile up on certain portions of the car. Such pile-ups cause air pressure buildups above atmospheric pressure. The pressure which is of major interest in the design of ventilation systems is called the static pressure. This pressure acts at right angles to the car surface. Two areas of positive static air pressure (static pressure above atmospheric pressure) are the front end grille and the lower portion of the windshield. Other car surfaces which are more parallel to the air flow, such as the roof and side panels, produce an airfoil effect resulting in a static pressure lower than atmospheric or negative static pressure. To take advantage of the various pressure gradients, the car ventilation air should enter the body at a positive static pressure area and leave at a negative static pressure area. The amount of air passing through the body is dependent on

Fig. 1—WIND TUNNEL SCALE MODEL. A one-quarter scale model of the Toronado was built of glass fiber for wind tunnel tests. Ink droplets on the surface of the model provided a graphic representation of air flow over the model. Smooth, parallel lines indicated smooth air flow; swirls and irregular patterns indicated turbulence. The model shown in this photo was oriented with the front right corner of the model facing the direction of air flow.

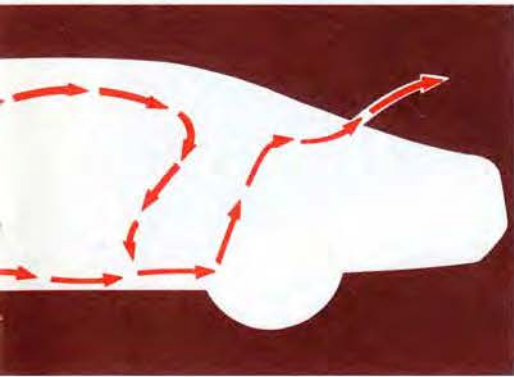

By TERRY A. TETENS
General Motors
Engineering Staff

System operates with
windows closed; vent
windows eliminated

the differential of the static pressures at the intake and extractor areas.

Wind tunnel tests were made with the cooperation of the GM Styling Staff to obtain the aerodynamic data to define the pressure pattern on the outside of the 1966 E body car. A one-quarter scale, glass fiber model of the car was used (Fig. 1). It had over 200 small tubes or "taps" built in flush with the surface to enable measurement of static pressure over a range of air speeds, car attitudes, and wind directions. A graphical repre-

sentation of air flow over the surfaces was obtained with ink droplets. Long, parallel ink lines indicated smooth air flow. Swirling, irregular patterns indicated turbulence. With the glass fiber model, it was very convenient to add clay and thus restyle car surfaces to record the resulting pressure and air flow pattern changes.

Wind tunnel results indicated that high positive static pressures existed at the front of the car and at the base of the windshield (Fig. 2). The remainder of the car had reduced static pressure acting on

it with negative pressure areas on the front fender just behind the fender leading edge, at the windshield header, at the rear roof pillar or sail panel, the tulip panel, and on the rear quarter panel. Static pressure was only slightly below atmospheric pressure at the tail lamp area. Of the two high positive pressure areas, the cowl area at the base of the windshield, used by GM for many years, was better (Fig. 3). The cowl is adjacent to the passenger compartment, thus requiring little ducting, and has good water separation potential. These tests supported continued use of this area for intake of air on the 1966 E body car.

Wind tunnel data also were used in locating air extractors on the car. Locating the extractors in some of the negative pressure areas was impractical when all factors were considered. For instance, if the extractors were placed on the front fender, extensive ducting would be required. The windshield header presented construction, space, and styling limitations. The extreme rear of the car was in the turbulent air flow wake with engine exhaust gases swirling in the area. The sail panels and rear quarter panels appeared to be more practical for air extractor locations (Fig. 4).

Wind tunnel data on the sail panel indicated an average pressure of -0.034 psi at a simulated car speed of 60 mph. To reduce the pressure further, an experimental sail panel flap was added to the model. This resulted in an average pressure of -0.049 psi beneath the flap.

System Design Studies Initiated

With the objectives of the ventilation system defined and the results of road and wind tunnel tests analyzed, design studies of many new and novel ventilation schemes proceeded. To evaluate some of these ideas, a 1963 Riviera was chosen as a test car. Its styling, seating arrangement, and exterior pressure distribution were closest of any current production car to that proposed for the 1966 E body car. Each idea, once incorporated as a working system on the test car, was tested on the road at the GM Proving Ground.

All of these tests were made in accordance with established Fisher Body test procedures. The tests measured: (a) the air quantity entering the passenger compartment; (b) the air velocity distribution at key locations inside the car; (c) the interior body pressure; and (d) water separation or the ability of the ventilation



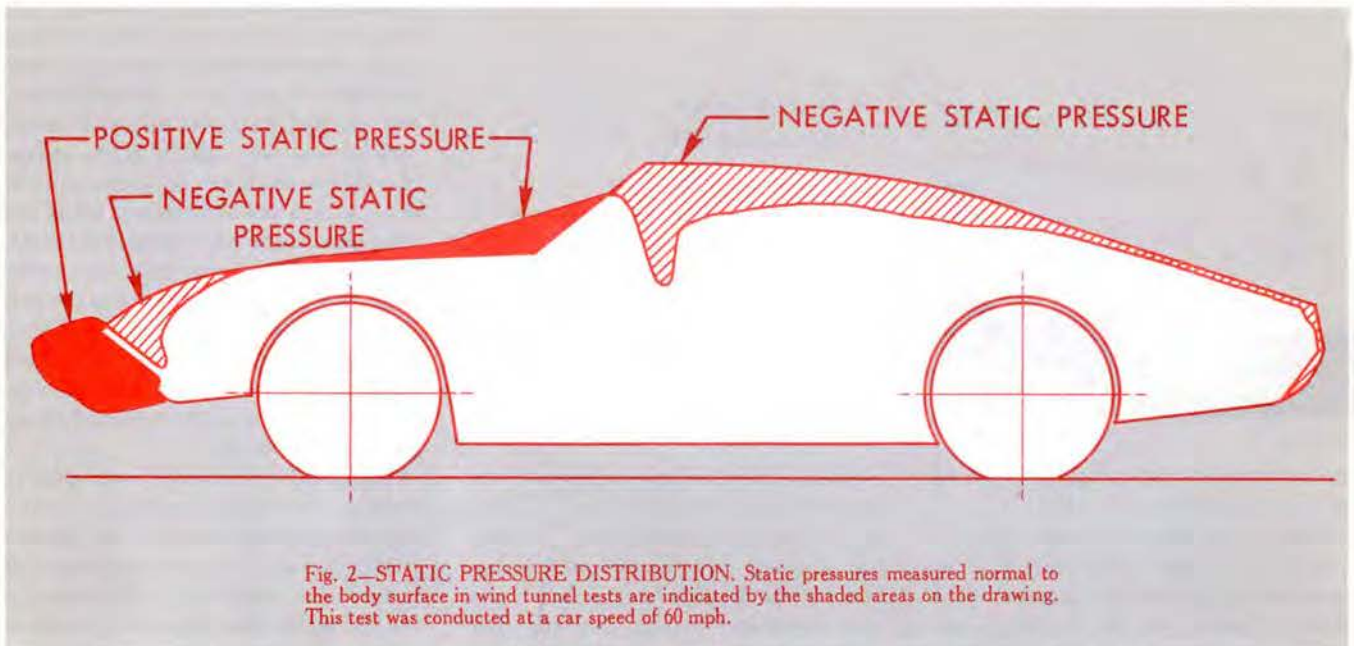

system to block the passage of water into the car body. Noise tests were made using binaural recording instruments. Tests also were conducted to determine if a carbon monoxide inhalation hazard existed.

All tests were made at steady car speeds of 30, 40, 60, and 80 mph under maximum vent and closed window conditions. With maximum vent conditions, the CV

windows and side windows were opened to produce the greatest pressure differential between the inside and outside of the body. This resulted in a large air flow into the car through the ventilation system outlets. With closed window conditions, all windows were closed and sealed producing the smallest pressure differential and air flow.

Since wind velocity would influence air quantity and velocity distribution values, tests were restricted to days when the wind velocity did not exceed 10 mph. Test runs were made in opposite directions perpendicular to the wind with the average of the two runs used as a true value.

To establish a ventilation performance base line, a production ventilation system was evaluated in the test car. At 60 mph, the production system delivered 824 cfm of air with maximum vent conditions, and less than 150 cfm with closed windows. Air velocity distribution tests indicated objectionable high velocity (2,625 fpm) air flow at the front passenger foot level and negligible flow throughout the rear seat compartment. These tests resulted in more specific design objectives for a closed window ventilation system. Air quantity should be at least 800 cfm with closed windows. Internal body pressures should be above atmospheric pressure at all times to help retard dust, water, and exhaust fume entry into the body. Air flow should be increased to the rear seat compartment. Some local air velocities should be reduced at the foot level of the front seat compartment and increased at the front passenger head and chest levels.

First Modified System Developed

The first modifications on the test car included installation of sail panel flaps. Static pressure developed beneath the

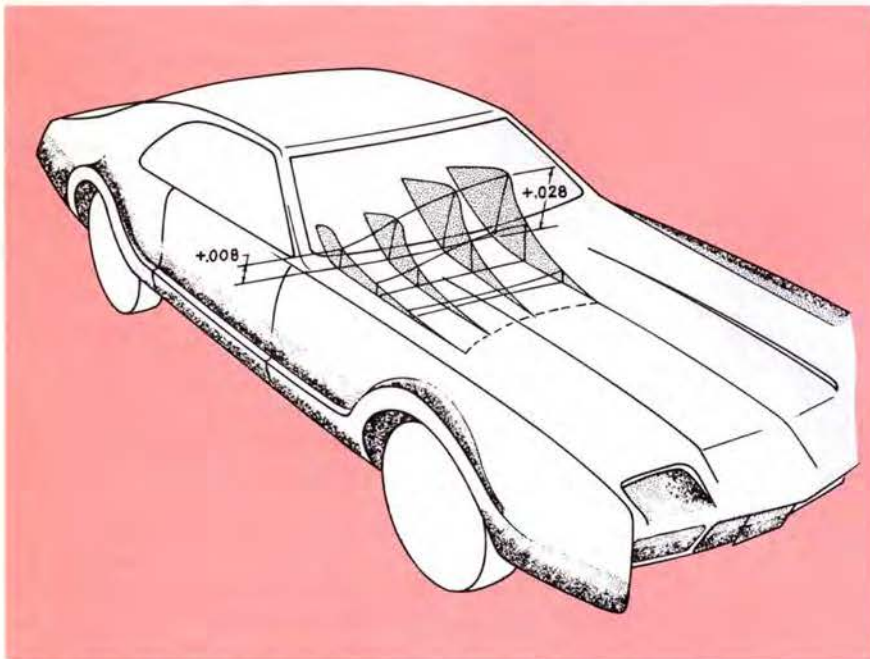

Fig. 3—STATIC PRESSURES AT COWL AIR INTAKE AREA. One relatively high positive static pressure area was at the cowl area at the base of the windshield. This drawing represents this high pressure area in psi above atmospheric pressure with the car travelling at 60 mph.

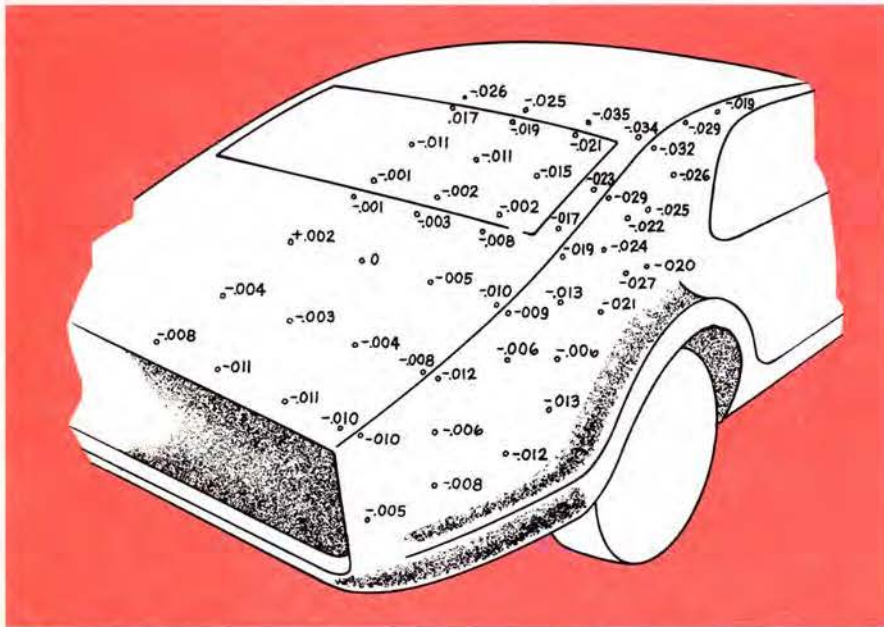

Fig. 4—REAR STATIC PRESSURE DISTRIBUTION. The distribution of static pressure in psi below atmospheric pressure is depicted by this drawing, based on wind tunnel tests with a car speed of 60 mph.

flaps in road tests closely coincided with wind tunnel tests (Fig. 5). In addition, extractor vents were built into each rear quarter panel. Each vent was flush with the panel surface and extracted air from the passenger compartment through the

trunk (Fig. 6). The static pressure at the vents was -0.009 psi at 60 mph. The cowl intake area at the base of the windshield was redesigned to a T shape to take advantage of the high pressure area on the centerline of the car. The original

intake grille area on the test car of 47 sq in. was enlarged to 161 sq in. The cowl area and configuration influenced the air quantity entering the passenger compartment (Fig. 7). Enlargement of the cowl intake grille area did not necessarily provide increased air flow. Air escaped at the ends of the grille because of the air pressure differential between the center and outer ends. By reducing the area at the ends of the grille, air flow into the passenger compartment was increased, but a point was reached where further area closure simply meant reduced air flow. The production defroster openings on top of the instrument panel were connected with the cowl air intake, thus providing ventilation as well as defrosting air flow. An opening was located in the package shelf at the rear window so air could flow into the trunk compartment to be exhausted by the rear quarter panel extractor vents. With these modifications, air quantity entering the passenger compartment was increased from 150 to 243 cfm at 60 mph.

Air distribution inside the car was the most perplexing problem. Variables such as sun load, seating arrangement, car body insulation and paint color, type of window glass, seat material, and even sex of the occupant made it impossible to assure that all people would be comfortable. Extensive tests with engineering and non-engineering men and women simulating customer operation were made. These tests indicated a wide variance of opinion about comfort, but generally a large quantity of air at low velocity at the head and chest levels was desired, especially under high ambient temperatures and quick cool-down, closed window conditions. The heads and chests of the test subjects were exposed to direct sun loads. By directing ventilation air at these parts of the body, effective heat transfer occurred making the subjects feel comfortable.

To supply the ventilation desired at the head and chest levels, three air outlets were placed on the instrument panel (Fig. 8). The center outlet obtained air from the windshield cowl plenum. This outlet also could be supplied outside air from an electric blower mounted as part of the car heater unit. The blower allowed ventilation air movement at low or idle car speeds. In addition, two ball-type outlets were installed at the ends of the instrument panel. These outlets were supplied air from the blower only. Tests

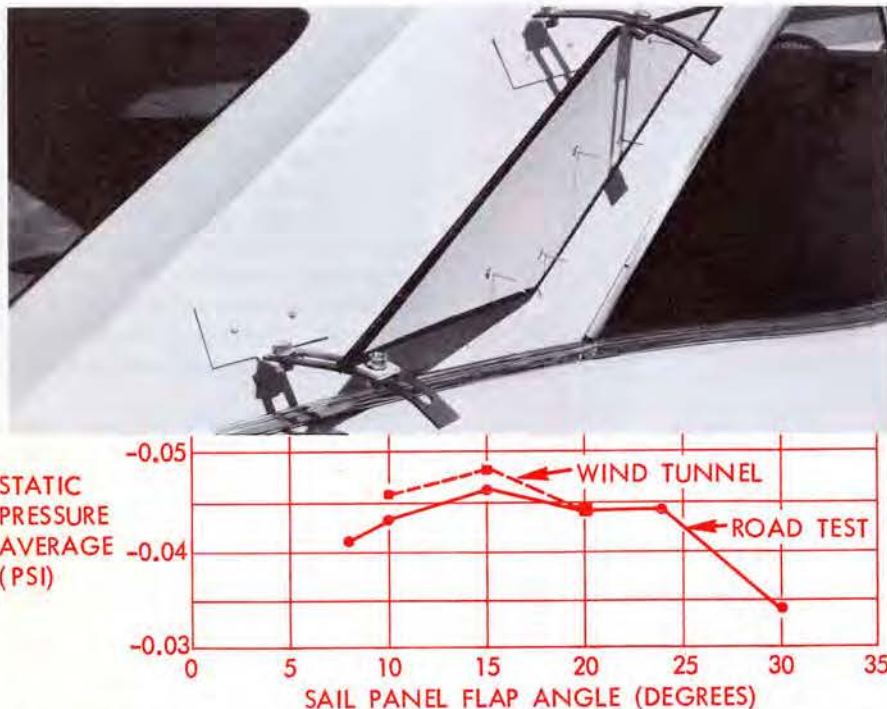

Fig. 5—STATIC PRESSURE BENEATH SAIL PANEL FLAPS. One modification of the car to determine the best extractor location involved the addition of sail panel flaps shown at the top. Static pressure data from road tests were in close agreement with data from scale model wind tunnel tests, as shown by the graph. Tests were conducted at car speeds of 60 mph.



Fig. 6—REAR QUARTER PANEL VENTS. Another possible location for the extractor was the rear quarter panel. This location was investigated by modifying a car with a flush extractor vent in the panel. Tests indicated that static air pressure at 60 mph in this location was -0.009 psi (relative to atmospheric pressure).

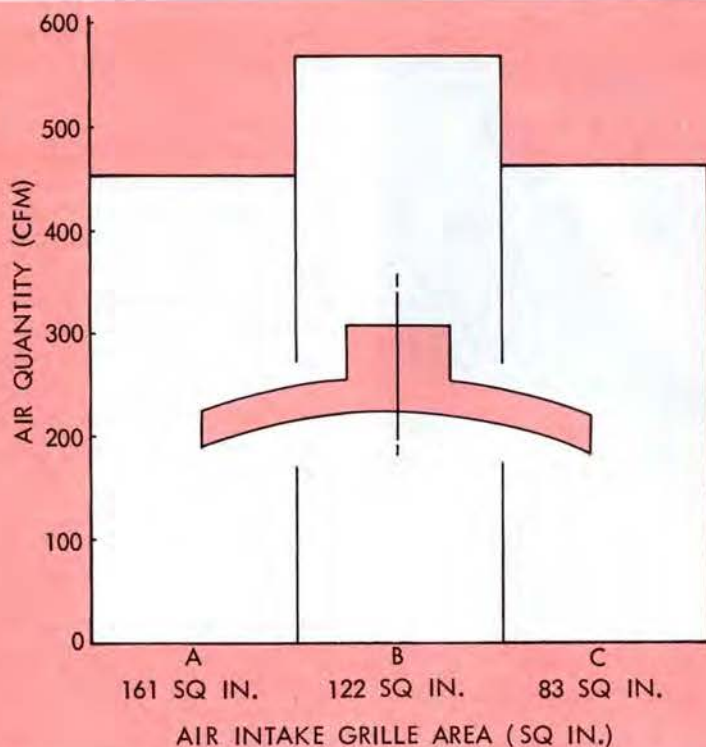

Fig. 7—AIR FLOW DATA—INITIAL AIR INTAKE DESIGN. The basic configuration of the initial air intake grille design is superimposed over a graph showing air flow data for that design. These data indicate that increasing the area of the air intake grille did not necessarily increase the quantity of air flow.

proved that the ventilation outlets on the instrument panel resulted in increased comfort at low car speeds and increased air movement for rear seat occupants. With the three additional air outlets on the instrument panel, air quantity increased from 243 to 751 cfm at 60 mph.

Second Generation System Developed

The completion of work by Oldsmobile and Styling on the design of the 1966 prototype E body car allowed Vehicle Development to simulate the 1966 body sheet metal on the 1963 test car. An improved version of the first ventilation system was installed giving growth to a second generation set of modifications. Revisions included modification of the T shaped cowl grille area to a uniform width across the car with an intake area of 246 sq in. The instrument panel outlet was increased to 28 sq in. The defroster outlets were reduced to 24 sq in. because tests proved the instrument panel center outlet to be more effective than the defroster ventilation outlets for providing high level air flow. The opening at the package shelf at the rear window was enlarged from 84 to 118 sq in. and modified so air would sweep the rear window and retard fogging. The rear quarter extractor area of 90 sq in. was not changed. It was anticipated that enlargement of the air intake area with the extractor area unchanged would provide a high positive internal body pressure.

The test car with the second generation ventilation system then was extensively tested enroute to Florida and the GM Desert Proving Ground. At these locations, additional tests and ride evaluations were conducted in high ambient temperature, humidity, and sun load conditions. Engineering personnel from Oldsmobile, Engineering Staff, Fisher Body, and Harrison Radiator took part in the tests.

The Florida tests disclosed that at car speeds below 35 mph, the velocity of the incoming air was not high enough to effectively ventilate the passenger compartment. An electric motor and blower were installed and additional ventilation outlets were installed in each end of the instrument panel. A third outlet was incorporated with the instrument panel center ram air outlet. These three outlets directed the air from the blower to the front passenger chest levels and to the rear seat area supplementing the ram air flow. Several cowl grille area configurations

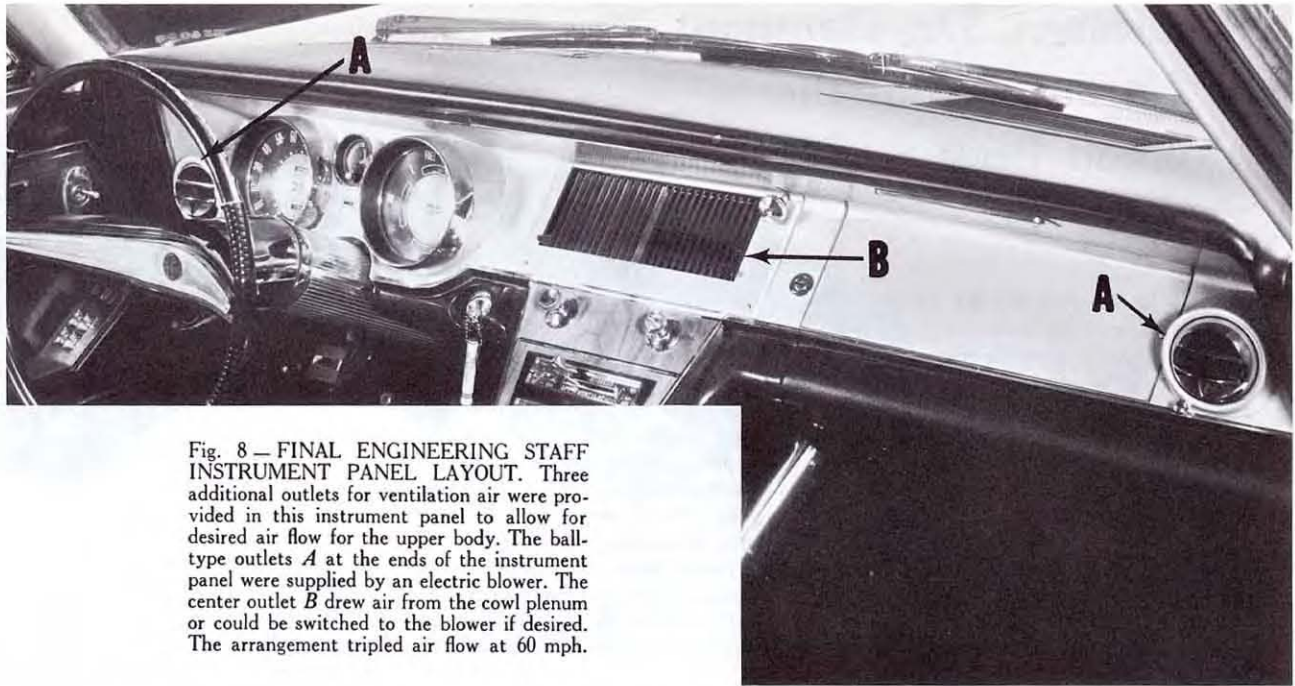

Fig. 8—FINAL ENGINEERING STAFF INSTRUMENT PANEL LAYOUT. Three additional outlets for ventilation air were provided in this instrument panel to allow for desired air flow for the upper body. The ball-type outlets *A* at the ends of the instrument panel were supplied by an electric blower. The center outlet *B* drew air from the cowl plenum or could be switched to the blower if desired. The arrangement tripled air flow at 60 mph. The arrangement tripled air flow at 60 mph.

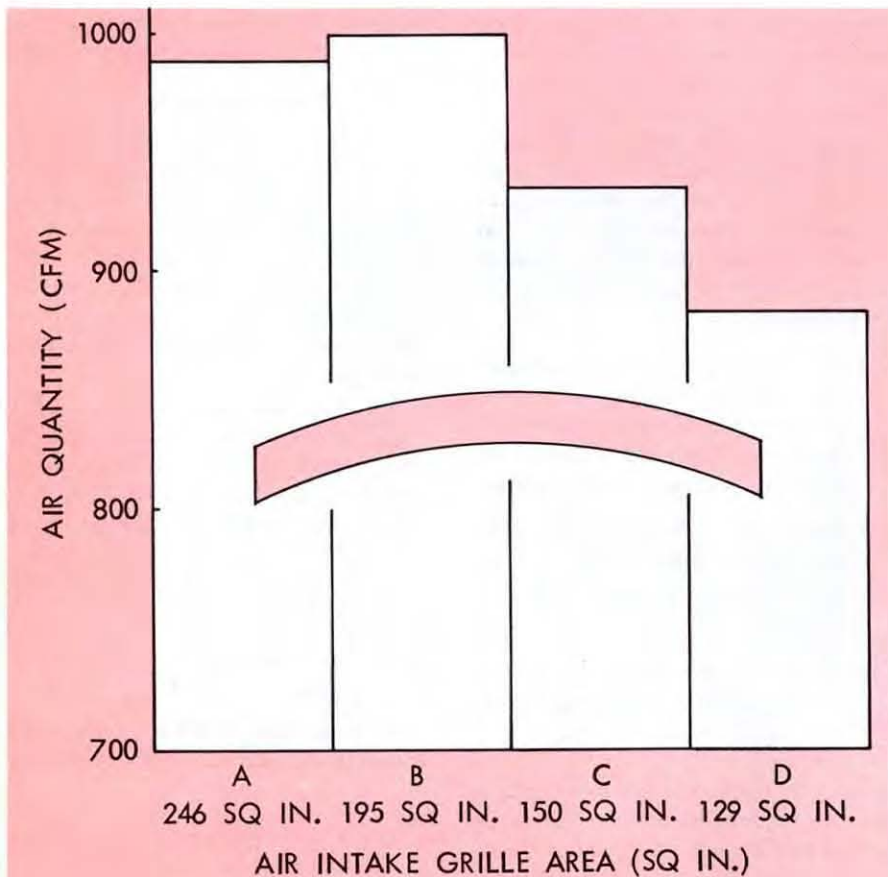

Fig. 9—AIR FLOW DATA—FINAL AIR INTAKE DESIGN. One of the GM Engineering Staff's final cowl air intake designs is shown superimposed over a graph showing air flow data. These data, while indicating a greater quantity of air flow for this design than for the initial design (Fig. 7), also show that beyond a specific point increasing the intake area results in a decrease of air flow. When the area became too large for this configuration, air escaped from the ends of the grille because of the air pressure differential between the ends and center of the grille.

also were tested (Fig. 9). Again it was found that reducing the area at the ends of the grille resulted in more air flow into the passenger compartment.

A thorough test sequence conducted in Arizona showed that the second generation closed window ventilation system delivered 911 cfm at 60 mph at an internal body pressure of +0.004 psi without the blower operating. Air quantity was 1,116 cfm at a body pressure of +0.007 psi with the blower in operation. The air distribution was divided 46 per cent low level and 54 per cent high level (head and chest levels). This ventilation system created an environment which was considered quieter and more comfortable than any other production open window or experimental ventilation system tested.

Conclusion

The Vehicle Development Group ventilation program served to explore the high quantity-low velocity concept of ventilation. The results were helpful to Oldsmobile and Fisher Body in the design of the production system. The final results of the cooperative ventilation program indicated that a quiet, comfortable, less expensive closed window ventilation system was possible, practical, and was an improvement over conventional ventilation systems. In addition, better air circulation assures that more uniform temperatures in both front and rear seats will be achieved quicker when the heater or air conditioning systems are in use.

The Design, Development, and Production of the Toronado Body

The vehicle architecture for the Toronado body, and its associated appearance and engineering features for both the interior and exterior, originated with the General Motors Styling Staff. The task of translating this into a completely trimmed and painted body that would be structurally safe, sound, and economical to manufacture was the assignment of Fisher Body Division. The task was not a simple one. The Toronado body is comprised of some 4,000 parts each of which had to be designed, developed, and tested. Design, development, and tryout also had to be applied to the dies needed to form the steel panels and stampings as well as the processing and production tools and methods used to fabricate individual parts and assemble the body. The Toronado program was the work not only of many engineers but of many groups of engineers who planned and coordinated their efforts to achieve a final end result. At Fisher Body, engineering assignments for a body development program are divided into specific areas of responsibility. This concept is carried into all phases of body engineering and manufacturing, has proven successful, and was applied in the design, development, and production of the Toronado body.

FISHER BODY Division is responsible for the engineering design and production of passenger car bodies* for the five General Motors car Divisions. The basic engineering design and development work is performed at Fisher Body's Central Office in Warren, Michigan. The fabricating of component body parts and final body assembly is carried out in 35 plants located in 27 cities. Broadly speaking, the Fisher Body activity involves first taking a car body configuration developed by the GM Styling Staff and designing its structural and feature aspects, next engineering the tools to form the body parts, then fabricating the individual components, and finally assembling the body and delivering it to the car Divisions for mounting on a chassis (Fig. 2).

Engineering Work Divided Into Three Basic Activities

The scope of engineering at Fisher Body leading to the development and production of a new body is divided into three basic engineering activities: (a) body engineering, (b) die engineering, and (c) production engineering (Fig. 3).

Body Engineering Activity

The Body Engineering Activity designs,

*The body provided to the GM car Divisions generally includes the completely painted and trimmed structure beginning at the sheet metal separating the engine compartment from the passenger compartment and extending to the rear bumper area (Fig. 1). Each car Division, in turn, develops and fabricates its own sheet metal for the hood, front end, grille, and front fenders.

develops, and tests the complete body and the parts needed for its construction. This function includes the preparation of all part drawings and engineering specifications needed for tooling and production operations. Within the Body Engineering Activity are four basic areas of responsibility. These are aptly described by the following nicknames associated with each of the four assistant chief engineers involved:

- *Mr. Future* (explores and develops new ideas—for example, worked out design criteria for the Toronado body from preliminary information and cleared the way for production design)
- *Mr. Outside* (designs the body shell, stampings, and hardware)
- *Mr. Inside* (designs trim scheme and hardware)
- *Mr. Prove-It* (builds prototype bodies and effects inter-plant coordination).

Die Engineering Activity

The Die Engineering Activity designs the dies required to produce the metal stampings that form the body and builds the wood models needed to develop the dies. This Activity also coordinates the work of all die shops within Fisher Body regarding the construction, tryout, and inspection of dies assigned to them. In short, this Activity's responsibilities begin with processing die design instructions

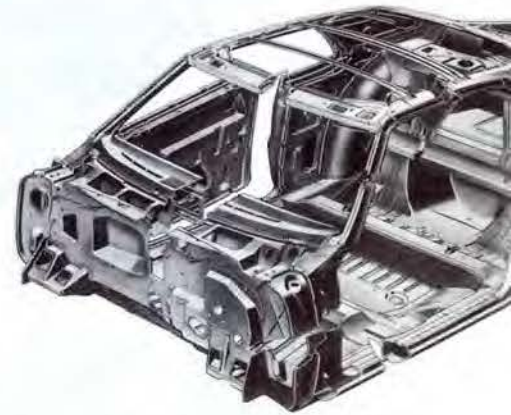

Fig. 1—TORONADO BODY. Two views of the Toronado body structure produced by Fisher Body are shown here. The structure, comprised of approximately 4,000 parts, is completely painted and trimmed before shipment to Oldsmobile Division for final assembly to the Toronado chassis.

and end with the actual stamping operations in various Fisher Body plants.

Production Engineering Activity

The Production Engineering Activity is responsible for the design, development, procurement, and follow-up of all tooling and equipment required by Fisher Body fabricating and assembly plants. This Activity is a diversified one and is divided into various related departments such as tool planning, tool design, and process development.

Although each Activity is staffed by engineers who are specialists in their area, they function as a team from the time a new body is first conceived until it is placed into production. The operating procedures of each Activity follow somewhat the same pattern for each new body development.

Engineering Work Keyed to Time Schedule

All work done by the three Activities is keyed to a master time schedule. During

Fig. 2—SCOPE OF FISHER BODY FUNCTION. The Fisher Body function in the Toronado program began with the engineering layout drawings and clay model developed by the GM Styling Staff. Using advance drawings provided by the Styling Staff, Fisher Body product, die, and production engineers set about designing and developing the body structure and the dies, fixtures, and tools needed to give it form. Process engineers then developed the methods needed for its fabrication and final assembly.

By FRANCIS E. SMITH
Fisher Body
Division

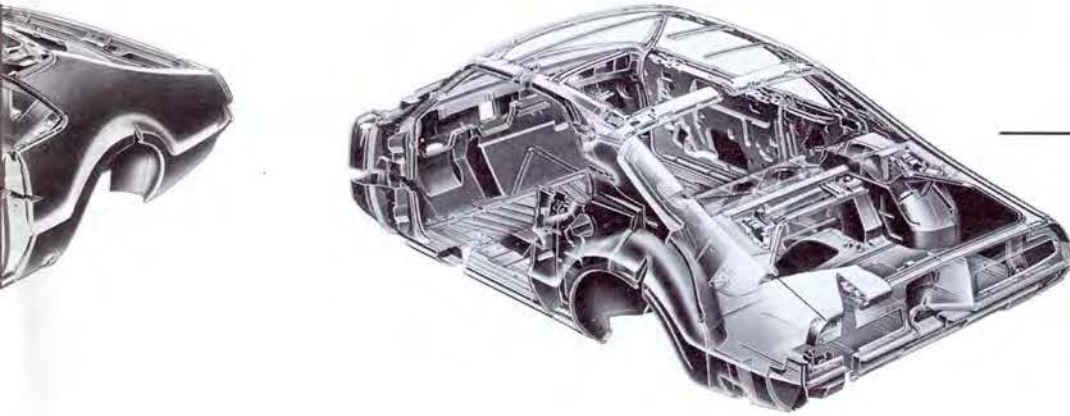

The challenge: engineer
and manufacture the body
designed by GM Styling

the early development stages of a body
the time schedule has general guidelines
of direction. Only limited personnel are

involved. As developments proceed, more
personnel are involved and a detailed
working schedule is mapped out. An

official starting date for production draw-
ings eventually is established and, from
this point on, every drawing and every
function is date scheduled.

This, then, summarizes the basic

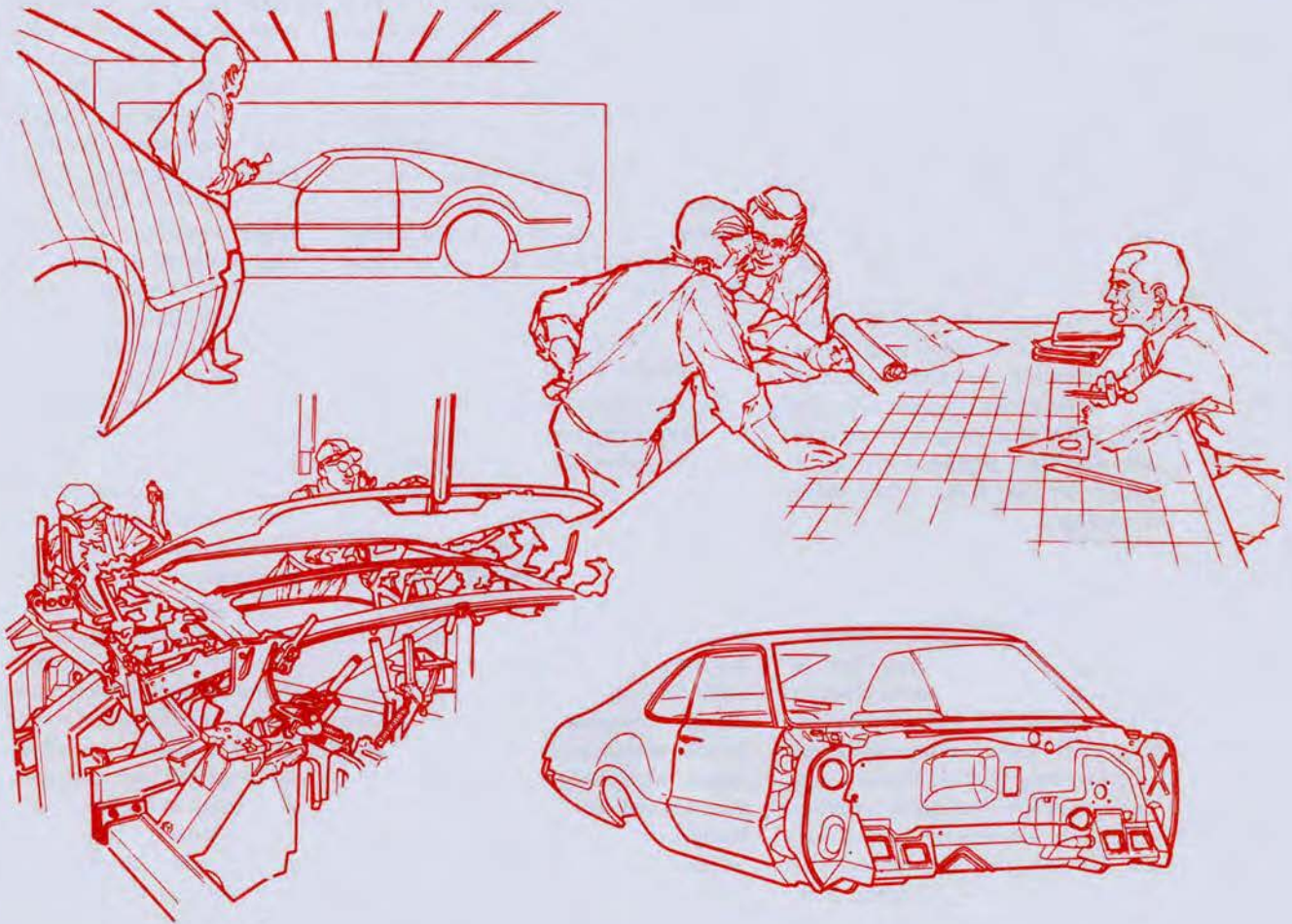

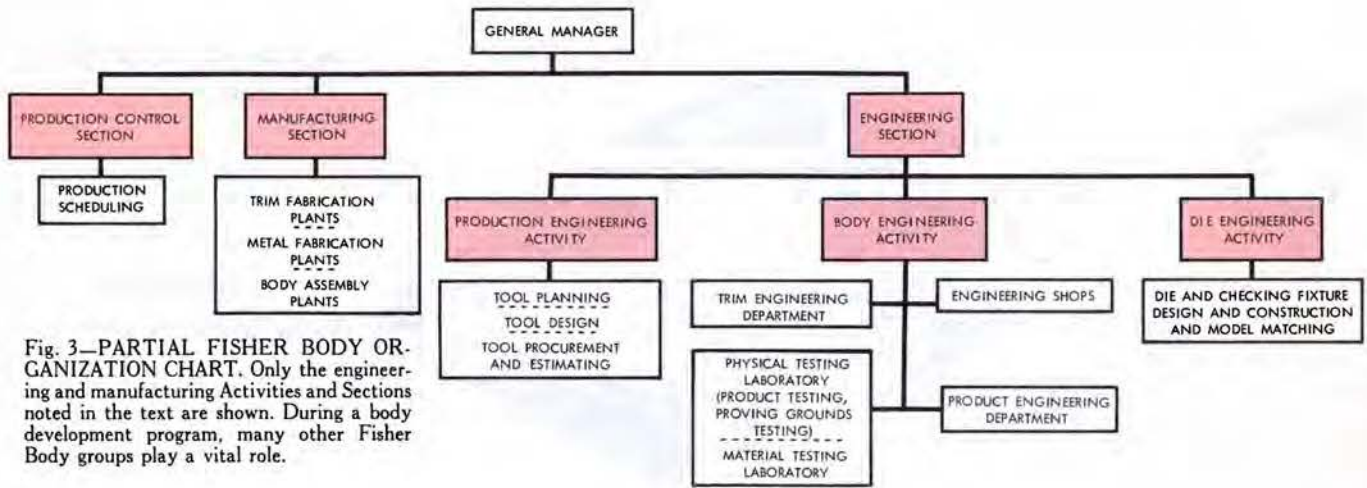

Fig. 3—PARTIAL FISHER BODY ORGANIZATION CHART. Only the engineering and manufacturing Activities and Sections noted in the text are shown. During a body development program, many other Fisher Body groups play a vital role.

engineering organization of Fisher Body. The following discussion tells how the three Activities, aided by other engineering groups at Fisher Body, functioned to design, develop, and produce the Toronado body.

Special Committee Established to Aid in Design Direction

The first concept of the Oldsmobile Toronado, which at the time was identified by the code designation XP-784, was a dramatic newness. In addition to distinctive styling, the general specifications called for a 119-in. wheelbase two-door car with front wheel drive. The exterior styling was to be complemented by equally distinctive interior decor. The specifications also included a ventilating system that eliminated the usual front door vent windows, wider doors for easier rear seat entrance, and a semi-integral frame type of body structure, supplemented by a sub frame for the front wheel drive power package.

The XP-784 represented a departure from conventional car design and a special approach was developed for the advance engineering program. Normally, when the GM Engineering Staff is involved in new car development it builds its own experimental vehicles for exploratory purposes. The resulting car design is turned over to a GM car Division and the body concept eventually reaches Fisher Body in a relatively basic status. For the XP-784 program, however, it was decided that the Engineering Staff would spearhead the design of the power package and the initial frame concept. Oldsmobile Division and Fisher Body

would concentrate on the design of the chassis and underbody. This allowed Fisher Body more latitude in the design and construction of a body best suited to the semi-integral frame concept.

The policy of joint design and development responsibility resulted in the creation of the Unitized Power Package Committee which consisted primarily of representatives from the Styling and Engineering Staffs, Oldsmobile, and Fisher Body. The committee functioned as a task force to formalize design decisions and a plan of action. Each section of the committee developed its assigned portion of the car and integrated these portions to create the XP-784.

Pretest Vehicles Aided Advance Engineering Program

Pretest vehicles were needed early in the advance engineering program to evaluate the power plant, front wheel drive components, proposed body frame structure, and the ventilating system. A pretest vehicle normally is the upper body of a current production car adapted to the proposed underbody. Current production bodies that most closely resembled the proposed XP-784 configuration were reworked for the pretest vehicles. Various changes were made to bring the pretest vehicles as close as possible to the ultimate design. Such changes included relocating the seats and shortening the rear axle-to-bumper overhang.

The pretest vehicles allowed the advance engineering program to proceed so that information obtained could be used to establish criteria for the final design and development program. Since there

were several design possibilities for attaching the chassis components to the body structure, several pretest vehicles were built in successive steps, starting with the simplest proposal. As test results became available, modifications were worked into succeeding pretest vehicles until the ultimate design was achieved (Fig. 4).

The first generation of reworked production bodies intended for the XP-784 pretest vehicles was designed and built within the first six months of the advance engineering program. Three bodies were handmade by Fisher Body for the GM Engineering Staff and one for Oldsmobile. A second generation of five bodies was built progressively as test results became available. A testing program initiated to evaluate the pretest vehicles had the Physical Test Laboratory at Fisher Body conducting static beaming (bending) and torsion tests while Oldsmobile performed dynamic shake and road tests. Through this cooperative testing program, a maximum amount of coverage resulted with a minimum amount of duplication.

The final phase of the advance engineering program was to analyze the test data and design a proposed underbody. Proposed changes were made and evaluated in the last of the second generation of pretest vehicles. The ventilation system was explored and evaluated on a separate group of pretest vehicles.

Test data obtained from the pretest program aided in establishing the direction the final body design would take. Two basic areas where this occurred were the body understructure and the ventilation system.

Body Understructure

Among the considerations favoring the integral frame construction was the possibility of taking advantage of a flat floor by the adoption of the front wheel drive. For example, it would not be necessary to "bump up" the floor on the sides near the rocker panels to accommodate a chassis frame. This, plus the elimination of a drive line tunnel, permitted a level floor from door to door in the total passenger area.

As is customary with integral frame construction, additional strength was designed into the overall body structure. Most of this supplementary structure was designed into the under-the-floor construction which eventually consisted of box-shaped rocker panels (Fig. 5) and heavy cross bars. Frame rails formed an extension to the rockers to continue the beaming strength rearward to the bumper. A rear end bar bridged the frame rails to gain increased structure.

Ventilation System

The decision to build the Toronado without a door vent window improved the styling and eliminated windnoise, but introduced some design considera-

tions. Prior experimentation had indicated that passenger compartment ventilation could be provided without a door window vent; however, the final design had not been established. It was known that the air could be admitted through the shroud vent grille below the windshield. To move the air through the body an air exhaust device, and its proper location, was required.

Various locations for a rear exhaust were evaluated by reworking existing model cars. It was determined that the area above the belt line and immediately below the back window was well-suited for the exhaust. Road tests were conducted to obtain air flow and air pressure data on the inside and at the outer skin of the car. These tests were conducted during the pretest vehicle stage under a range of weather conditions and temperatures. In addition, wind tunnel smoke tests were conducted to determine an efficient louver angle for the rear exhaust grille. Various ventilation system proposals were designed and tested with progressive improvement in overall performance and adaptability. Eventually, a final design of the ventilation system

was developed and approved for production (Fig. 6).

Preliminary Engineering Involved Clay Model Review

The chronological development of a new body at Fisher Body progresses through various overlapping stages that can be generalized as follows:

- (a) Styling Staff drawings
- (b) Preliminary body development (including pretest)
- (c) Body design development and body drawings
- (d) Prototype body building and testing
- (e) Tooling and processing preparations
- (f) Pilot production and testing
- (g) Final production.

At approximately the same time that the first pretest vehicles were undergoing tests, other related events were taking place at Fisher Body as the XP-784 program progressed. The first visual concepts of the Toronado had been preliminary engineering layout drawings prepared by the Styling Staff. These drawings were used to prepare a full

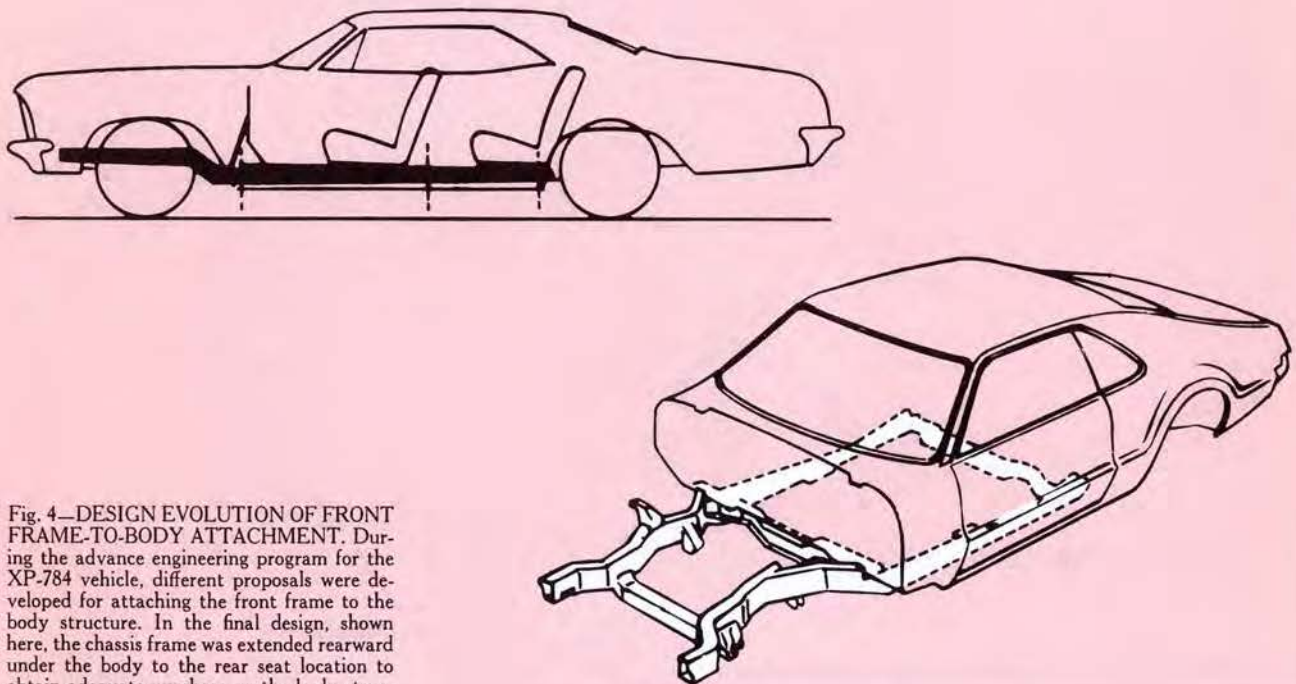

Fig. 4—DESIGN EVOLUTION OF FRONT FRAME-TO-BODY ATTACHMENT. During the advance engineering program for the XP-784 vehicle, different proposals were developed for attaching the front frame to the body structure. In the final design, shown here, the chassis frame was extended rearward under the body to the rear seat location to obtain adequate purchase on the body structure. This spread the structure load over a large area.

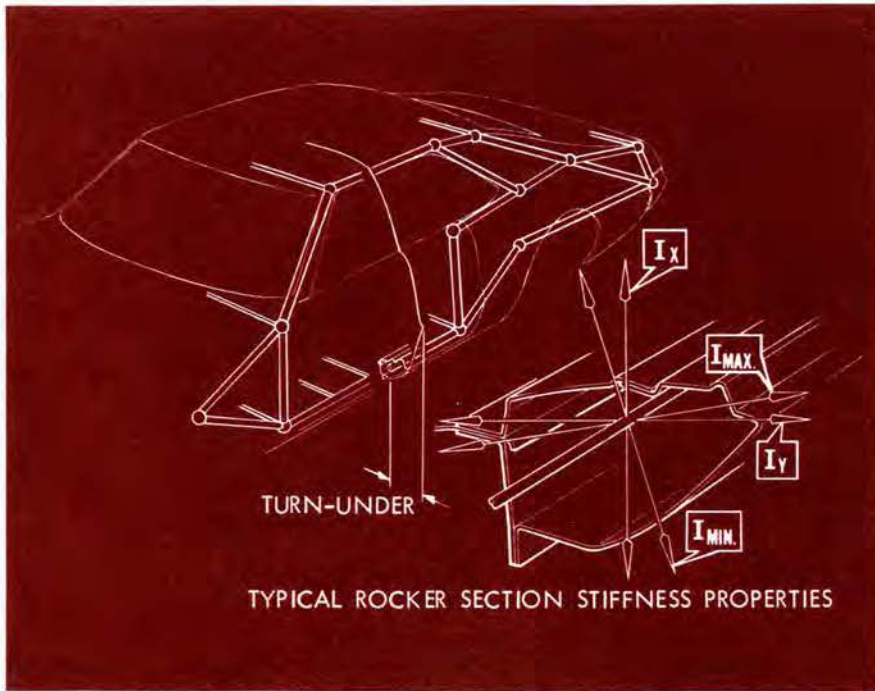

Fig. 5—STATIC BODY ANALYSIS. The automobile body, like any other load bearing structure, must be carefully analyzed in the developmental stage to assure that each part is structurally correct. A typical component analyzed in detail was the rocker panel section. Rocker designs were developed and stress analysis applied to compute moments of inertia and torsional stiffness. The final production rocker design is shown above with the sectional properties that were calculated during the body analysis. Maximum overall beaming stiffness was attained by increasing the cross sectional height in the areas rearward of the doors.

size clay model and showed the architecture of the car, its surface contours, and the seating arrangement. Styling also built a seating buck to show passenger placement. Fisher Body reviewed the program planning with Styling and, using the Toronado introduction date as a target, prepared a tentative engineering drawing schedule for all major parts. This schedule included such major stampings as door panels and specified when production drawings were to be started and when they were to be completed. The schedule then was released to the engineering Activities for their use in preparing budgets and manpower requirements.

As the clay model passed through the evolutionary process of evaluation and refinement, meetings were held with Styling to assure that the finely styled body would be practical to manufacture. Fisher Body engineers were consulted on such special items as hinging the wider doors, operating the door window glass with its compound curvature, and the structural requirements for the windshield pillar. Preliminary development engineering such as this was needed even before the clay model could be completed.

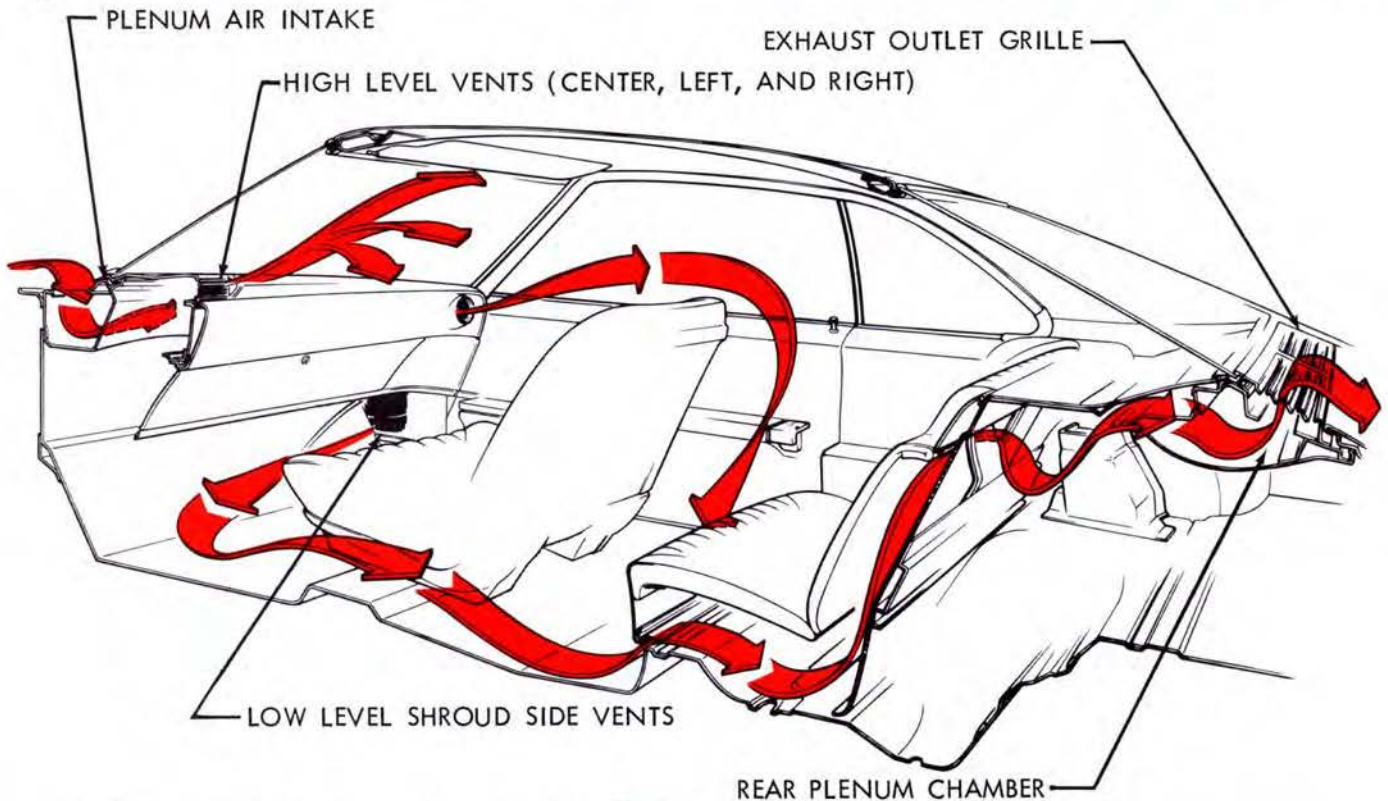

Fig. 6—VENTILATION SYSTEM. The ventilation system developed for the Toronado was designed to operate separately or in conjunction with an optionally installed air conditioning system. In the production system, shown above, air is drawn into the body through side shroud vents that are connected by means of a plenum chamber to the shroud vent grille. An additional high level vent operates in conjunction with the heater blower and the instrument panel air outlets. Air is exhausted rearward through a rear plenum chamber and out of the body through a pressure relief valve and rear exhaust grille. Installation of the exhaust system in the trunk presented a design problem from the standpoint of providing a system that not only would meet design requirements but also would provide suitable trunk space in that area. The problem was solved by designing a trunk hinge, not shown in this sectioned view, that stows away inside the vent exhaust chamber. The specially designed hinge serves to provide the trunk with ample luggage area.

During the preliminary development engineering phase, for example, Fisher Body determined by layout that swing-out type door hinges would provide the optimum entrance conditions for front and rear seat passengers. Fisher Body and Styling Staff engineers established the location of the leading edge of the door to provide clearance for the full dropping of the window glass. The smooth, continuous effect of fender, door, and side window gave the glass a non-uniform shape. To make it possible for the glass to drop through the door belt opening, Styling modified the glass surface to a developed shape in which the vertical section radii increased progressively from front to rear while maintaining substantially constant sweeps from top to bottom. To compensate for the changing shape as the glass lowered within the door, curved window regulator tracks had to be designed. Because of the wider door, larger hinges were designed to provide the door with additional support. Provisions also were made in the window mechanism and weatherstrips to provide stability, strength, and sealing of the window assembly.

Clay Model Viewed Differently by Activities

When the clay model was given tentative approval, Styling Staff drawings were prepared from information taken directly from the clay model. While these drawings were being prepared, a construction review of the approved clay model was held by Fisher Body personnel from the three engineering Activities responsible for making preparations for production. Each Activity reviewed the clay model from the standpoint of Fisher Body's final goal—the production of a sectionalized body shell that met rigid structural, fabrication, and assembly specifications.

The Body Engineering Activity's review was concerned with many things, the first of these being a structurally sound body. The Body Engineering Activity also contemplated the final mechanical solutions that had to be worked out for the wider doors with the compound curved window glass and the numerous drawings needed for the many hardware items. New seats and soft trim also had to be considered to complement the body and hardware design.

The Die Engineering Activity reviewed the clay model from the standpoint of determining if the various body panels

could be fabricated in dies and, if so, to assure panel quality and production reliability. It was determined, for example, that to eliminate the possibility of flutter in the large rear quarter panel, additional crown would have to be added to the panel surface above the wheelhouse opening.

The Production Engineering Activity looked at the clay model from the standpoint of determining the location of weld joints and the orientation of major components necessary to assure efficient assembly of the body. The clay model review established the methods of assembly and laid the foundation for the tool development engineering that was to follow. Recommendations and proposals were made to facilitate construction and provide guidelines.

Engineering Program Begins

When Styling Staff drawings were completed, they were released to Fisher Body. This signalled the official start of the Fisher Body engineering program for the Toronado body. All preceding preparations had been groundwork for the official starting date. With the establishment of the starting date for master draft work, an official time schedule was prepared for all detail and product assembly drawings. A master analysis chart (Fig. 7) prepared for the overall program indicated its overlapping nature and the variety of events that were to occur during the time span from the start of product drafting until the start of production.

The drafting program at Fisher Body began by obtaining advance Styling Staff drawings for preliminary layout work in developing advance design and typical sections. The typical sections were drawings of a constant section or feature of the body structure that showed the relation of one part to another. The typical sections, when approved, formed the basis for the design of the complete body. The typical section drawing phase was most important in clearing the way for the maintenance of established working schedule dates.

Master Drafts Made for Body

All lines that eventually described the appearance of the Toronado body were made on full size drawings called *master drafts*. These drafts were made on aluminum plates prepared with coats of flat

white paint having a minimum thickness of 0.008 in. The drafts were first scribed with vertical and horizontal grid lines, spaced five in. apart, to promote precision by minimizing errors caused by any slight expansion or contraction of the metal plate. Errors in scaling also were eliminated since any point on the draft could be located by measuring its relationship to the nearest grid lines. The draftsman used a 10 carat gold stylus instead of a pencil.

Points in a horizontal plane were established in reference to a vertical zero line, which represented the front of the dash panel assembly. Points in a vertical plane were referenced to a horizontal line representing the main top of the chassis frame. Points pertaining to the width of the body were related to the centerline of the body.

Instead of making one complete master draft of the entire Toronado body, the drafting work was divided into five major departments: (a) front end and instrument panel, (b) door, (c) roof, rear quarter, and rear end, (d) seats and underbody, and (e) interior trim appointments. All surfaces developed by the various departments had to blend together. After the outer body shell was surfaced, layout was started for the inner surface, hardware, reinforcements, and seats. Approximately 25 master drafts were started for the Toronado body program.

Detail Drawings and Die Plates Developed

Individual parts from each of the master drafts were detailed on separate drawings. Parts of any complexity that were to be made by dies were detailed on a *die plate* (a full size drawing also prepared on aluminum plate). The die plate provided all surface and contour lines needed to fabricate a specific part and simplified construction of die models, dies, and fixtures which were to follow. Except for moldings and ornamental parts, all die plates were drawn to show the inside (master) surface of metal. The die engineer specified this master sheet metal surface by determining the direction of drawing or forming a part.

Trim Engineering Program Started

While work proceeded on the master drafts, developments also were taking place with interior design and development. Just as the body, die, and production engineers met and consulted with

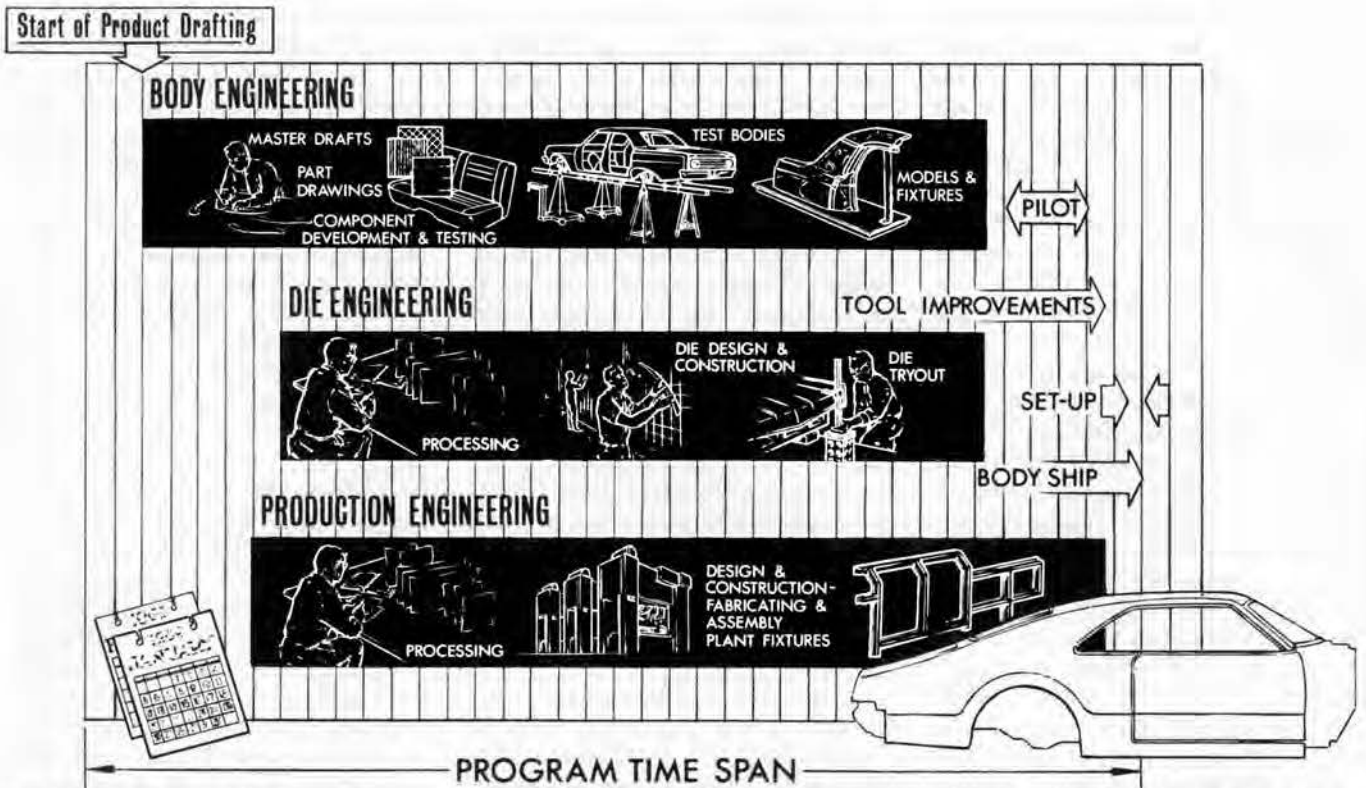

Fig. 7—MASTER ANALYSIS CHART. Time is an important ingredient once master draft work is initiated on a new body design and development program. All functions—from the start of product drafting until the start of actual body production—are date scheduled. This chart summarizes the major functions of each of the three engineering Activities in the Toronado body program and indicates the overlapping nature of events.

Styling during development of the clay model, trim engineers also consulted with Styling during the original conception of the interior trim design for the Toronado body before Styling drawings were made.

Trim engineers assisted Styling so that the finished interior trim design would not only look appealing but also would be practical to produce. The fabrics selected for the interior trim, for example, were reviewed by trim and textile engineers for ease of tailoring, strength, or any objectionable fractures at joining locations due to the weave of the cloth.

About the time that the 1964 model GM cars had been on the road for several months, trim and hardware engineers at Fisher Body began to receive Styling Staff interior drawings for the Toronado. The interior styling theme visualized continuous lines from the instrument panel sweeping rearward through sculptured door and rear quarter panels and blending into a contoured shelf (Fig. 8). After the interior drawings were reviewed, trim engineers prepared cost drawings that

outlined the various types of surface materials and construction as well as the types of padding needed to achieve the proposed design. When the trim design was accepted by Oldsmobile, quarter-scale drawings were made of the finalized trim design. The release of these drawings served as the official start of a detailed trim engineering development program.

Die and Production Engineering Programs Begin

At this point in the chronological development of the Toronado body, master draft work had not advanced sufficiently to make detail part drawings needed for die and fixture construction, tooling, and plant layout. The product engineers of the Body Engineering Activity were concentrating on problems of design and construction and were using data obtained from the pretest program as an aid in providing design direction. The tooling program, however, could not wait for released part drawings. This meant, then, that while the product engineer continued with his work, two people were looking over his shoulder—the die engineer and the production engineer.

Die Engineering

The die engineer looked over one shoulder of the product engineer to obtain preliminary information for his use in

planning the processing of die design instructions and fabricating sequence. The approach used by the die engineer to determine the most practical sequence to use to fabricate body panels, such as rear quarter fender panels, was as follows:

- Analyze the product design to determine manufacturing requirements
- Plan the sequence of operations
- Specify general die design characteristics
- Designate necessary press equipment
- Integrate the mechanical handling requirements.

To aid in this procedure, the die engineer used information available from the results of a continuous die development program at Fisher Body in die construction techniques, reports from test projects that recommend new die materials and construction methods, plaster take-offs from the Styling Staff clay model, draw die binder set-ups*, and partial pine models.

Plaster take-offs of the Styling clay model, together with experimental draw die binder set-ups, enabled die engineers to determine accurately the general die

*Plaster engineering models of the female portion of a draw die used for evaluating critical draw conditions, metal flow, and sheet metal wrap on the binder surface prior to die design.

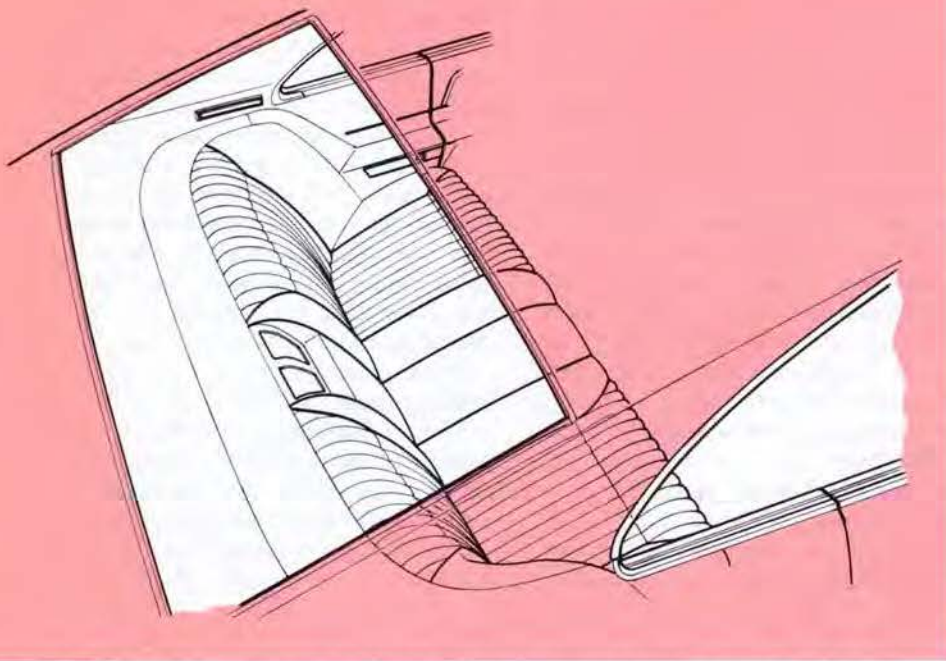

Fig. 8—INTERIOR TRIM DESIGN. The design developed by GM Styling for the interior of the Toronado body had to be made a reality by Fisher Body trim and textile engineers. The rear seat back, for example, was styled to blend into a contoured shelf. It was the job of trim engineers to develop the type of construction and padding needed to achieve the proposed design.

conditions that affected panel fabrication—that is, panel tipping[†], flange flare conditions[‡], and the draw die binder development. Construction meetings helped maintain a close liaison between body, production, and reliability engineers. These meetings were held throughout the Toronado program and served as a continuous check on the body's manufacturing feasibility. In one of these meetings, for example, the die engineer recommended that the lock pillar be welded to the rear quarter panel rather than use an integral pillar design. An integral pillar-to-quarter panel design would have created an undesirable sheet metal lay on the draw die binder. Wrinkles would have been introduced in the sheet metal blank and the increased draw depth would have caused skid marks at the panel feature lines. Draw die and panel quality considerations, therefore, dictated that separate lock pillar and quarter panels be provided.

Partial pine models were constructed

[†]The orthographic rotation and projection of a body panel from car position. Panel tipping is used to achieve the optimum in fabrication and handling conditions.

[‡]The rotation and development of body panel flanges from the finished body position to die position. Flange flaring provides optimum draw and trim conditions prior to finish flanging operations.

to provide detailed information on certain specific body areas. By using pine models, important die conditions were more easily analyzed and changes in product design to improve die conditions were accurately determined. As die plates became available the partial pine models were replaced by a master wood die model (Fig. 9). This model served as the primary source of information for all pattern, profiling, and spotting block construction and for analyzing all fabrication and checking fixtures.

Production Engineering

Meanwhile, the production engineer was looking over the other shoulder of the product engineer, since his work also could not wait until the completion of all part drawings.

Using preliminary body design information, program estimates were prepared enumerating anticipated production equipment and tools. With the assistance of cost accounting, the estimates were converted to a project fund request and submitted to the Fisher Body Finance and Accounting Activity for authorization. These estimates included equipment from simple hand tools to stamping presses.

Detailed Die and Production Programs Prepared

The next step was the preparation of detailed specific program estimates by the Die and Production Engineering Activities. A schedule of procedure, sequence of work, and manpower requirements for each phase of the body program was established. This allowed various departments within each Activity to establish schedules for tool and fixture design, construction, and follow-up. To establish the schedules, planning time, quantity of tooling assignments, principal panel gaging control layouts, and welding layout study requirements were evaluated using empirical statistical methods based on previous body programs.

Other factors such as production volume, inter-plant shipping, and cost considerations relative to producing various sub-assemblies in a high volume parts fabricating plant or a low volume body assembly plant were evaluated. Since the Toronado was scheduled for relatively low volume production, it was determined that the majority of sub-assembly operations for the body would best be accomplished at one source in a final body assembly plant.

Body Assembly Plant Selected

Because sufficient sub-assembly area was not available at Fisher Body's Lansing, Michigan, plant (where Oldsmobile bodies are assembled) without interfering with the production of bodies for other Oldsmobile car models, the decision was made to build the Toronado body at the Fisher Body Euclid, Ohio, plant. This decision created a problem of how to transfer the completed bodies to the Oldsmobile plant in Lansing. Bodies produced at the Euclid plant had been shipped by rail, but railroad facilities for receiving and handling bodies were not available at the Lansing plant. For this reason, the decision was made to ship the Toronado bodies by truck. Special haulaway trailers and body carrying pallet trucks had to be designed and built and revisions had to be made in the Euclid plant's shipping facilities to match those at the receiving plant.

Preliminary Weld Studies Made

As the program progressed, the Body Engineering Activity provided Production Engineering with experimental drawings of the body structure that detailed

the joint assembly and welding conditions. Production Engineering evaluated the proposed joints from the standpoint of tool and welding gun clearances, fixture and panel loading conditions, and gaging. Cardboard, metal, and plastic models of proposed joints were made to illustrate assembly methods.

Preliminary weld studies were made to show the proposed assembly methods as well as the type and quantity of weld joints and the equipment requirements. The shipping methods engineer used these studies to make preliminary nesting and shipping studies for inter-plant shipment.

Prototype Test Bodies Built

The preliminary steps of planning and evaluating prepared the way for direct action when final product drawings be-

came available. The first of these drawings were completed within several weeks after the official starting date of master draft work. The program of providing all dies, fixtures, and tooling necessary for production then moved into high gear, but still required many months to complete. This meant that parts and bodies made from the tooling would not become available in time for required testing; and bodies exactly like production Toronado bodies were needed for laboratory and GM Proving Ground work. This is where Mr. Prove-it entered the picture.

The Engineering Shops of the Body Engineering Activity made quick tooling and built production prototype bodies by hand. Every part was accounted for, ranging from fender panels to rubber sealing strips.

Some of the prototype bodies were designated as *test bodies* and were built for

Oldsmobile and Fisher Body's Physical Test Laboratory. These bodies were used to prove production part design, performance, and assembly methods. The test bodies were subjected to various tests to determine and expose any sealer defects, squeaks, wind noise, wear quality of trim and hardware, riding qualities, handling, performance, and structural soundness. Among the numerous scheduled body tests were: beaming (bending) and torsional rigidity of the body, water and dust, door slam, GM Proving Ground durability, corrosion, and cold room.

Other prototype bodies were designated as *design check bodies*. These were built for Oldsmobile to coordinate the body to the chassis and other Oldsmobile supplied components. The design check bodies emphasized the attaching surfaces.

Still other prototype bodies were designated as *sample check bodies*. These were

Fig. 9—MASTER WOOD DIE MODEL. Accurate models such as shown below served as the primary source of information for analyzing fabrication and checking fixtures.

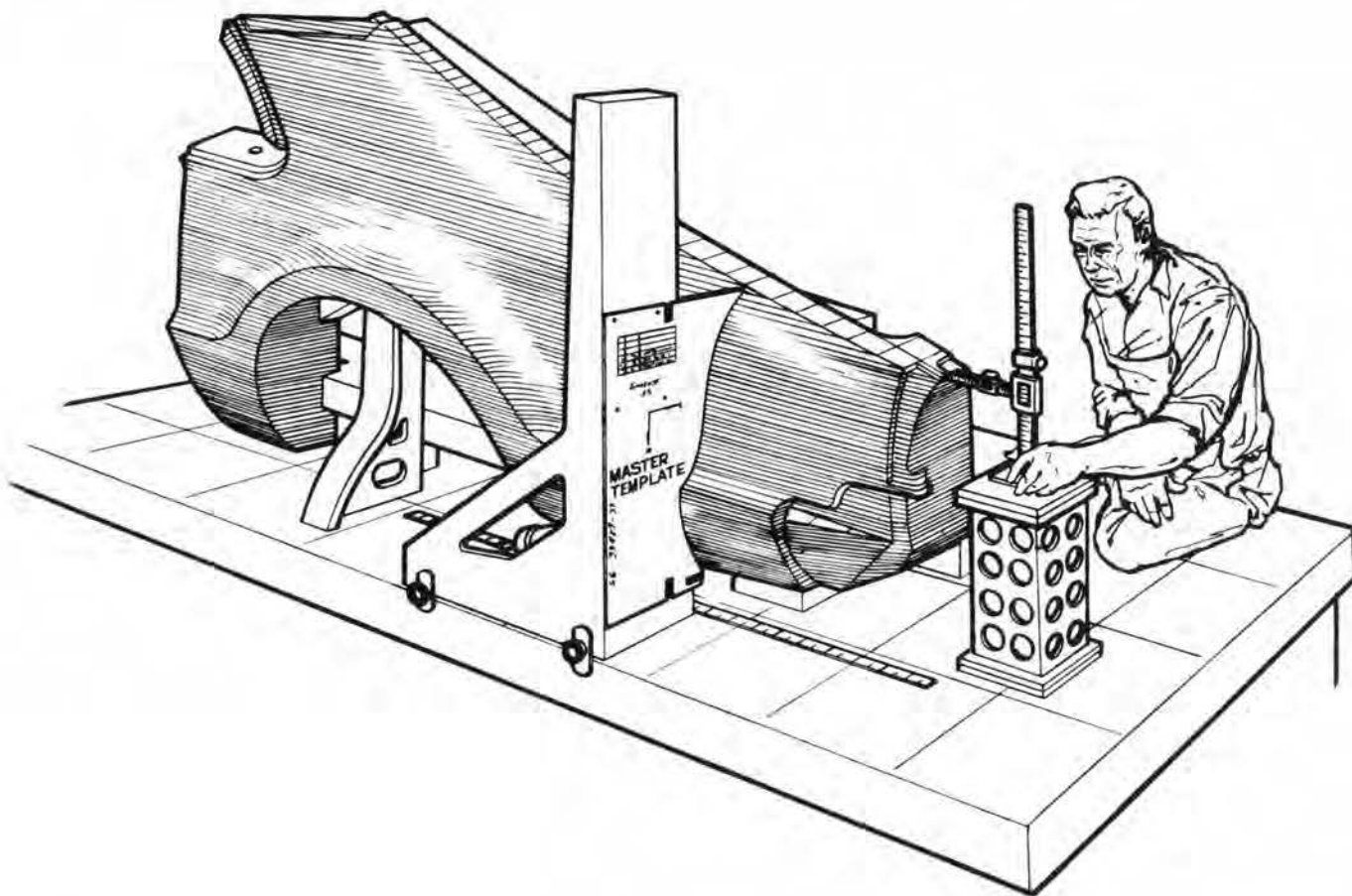

built for Fisher Body use in fitting hardware, glass, weatherstrip, and moldings. The sample check bodies emphasized dimensional accuracy.

Wood Bucks Built for Molding and Trim Work

The prototype test bodies provided an excellent means for testing the physical and mechanical properties of the Toronado body, but a different means was needed to develop and prove the molding and trim design ideas. This had to be done long before any prototype bodies were available, and before expensive dies were built for the moldings. To gain this time, and to prove design ideas, partial three-dimensional bodies were made of wood.

Working to lines traced from the master drafts, the Engineering Shop constructed accurate wood bucks of body areas (Fig. 10). Exterior and interior moldings were modeled in clay. The compromise solutions reached by Fisher Body based on information received from GM Styling were presented for the first time in three dimensions. Also developed for the first time were those areas for which information was not received as yet from GM Styling, such as junctions of body side molding treatment involving the different sections.

Die models for production tooling were brought to the bucks for comparison of line and appearance acceptability. This was essential to assure fidelity of reproduction.

Trim Engineering Program Entered New Phase

When the basic interior trim design was released in the form of quarter scale drawings, Trim Engineering started its development program. Layout drawings were studied to pinpoint various physical conditions that would affect the interior trim of the body such as: arm rest-to-window regulator handle clearance and seat-to-arm-rest clearance. Hand made set-ups were used to aid this study.

Trim Buck Built

At this stage of the Toronado development program, Trim Engineering obtained preliminary prints of the body shell detail parts and designed an accurate full size interior replica known as a *trim buck*. This wood buck incorporated all body interior structure and surfaces and was used to evaluate trim provisions and develop pat-

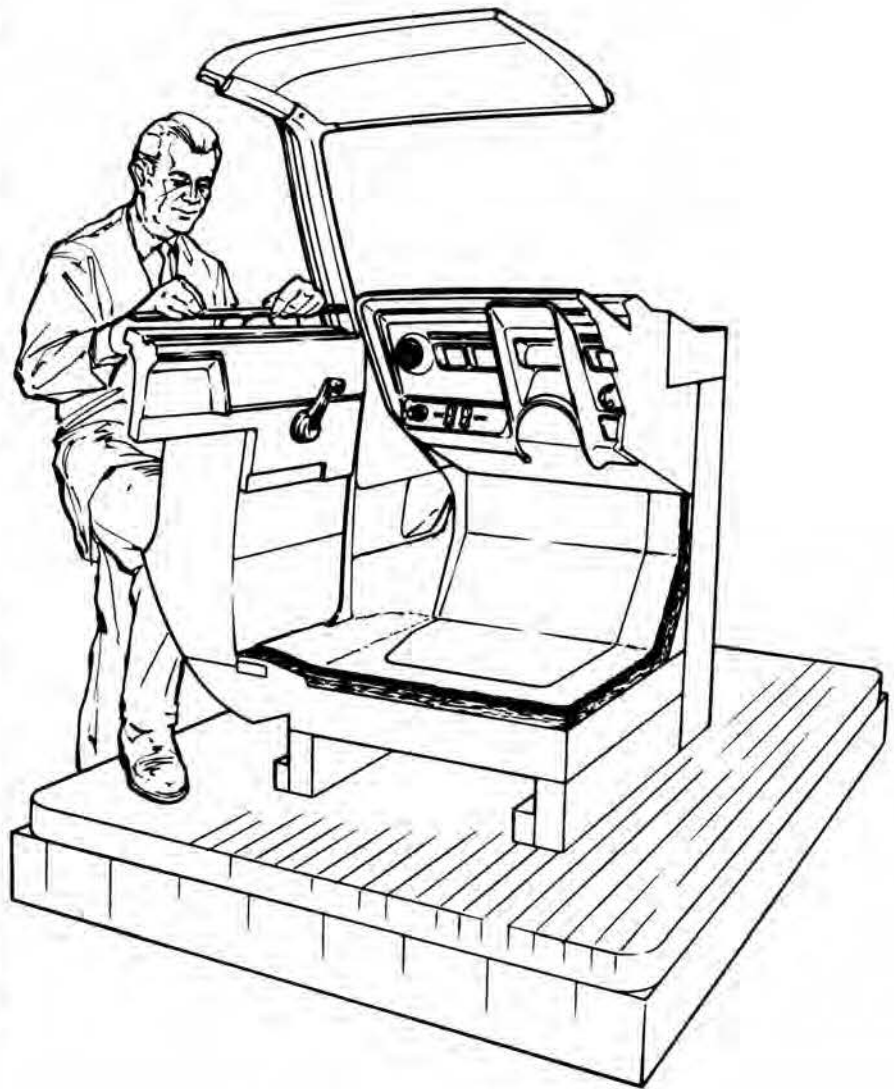

Fig. 10—TRIM BUCK. To prove the accuracy of molding and trim designs, wooden bucks such as the one shown here were built.

terns. Many appearance displays and clearance checks were placed in the Toronado trim buck to determine feasibility and assure completeness and correctness of the interior body trim. While this phase was in progress, other groups in Trim Engineering were working on the development of headlinings, listing wires and bows, windlaces, trunk trim, carpets, sunshades, and package shelf covers.

One feature of the Toronado body that complicated interior trim development was the Styling Staff concept of the rear shelf cover which blends into the rear quarter trim. To accomplish this concept,

an injection molded shelf cover was indicated. A study of materials revealed that a synthetic material having a glass fiber content gave the best results. The original design called for a one-piece shelf cover but because of possible assembly variations, a three-piece construction was considered more practical. This type of shelf cover meant a departure from the conventional use of retaining clips and required the use of hooks and bosses molded into the shelf cover. Retention was accomplished with spring nut fasteners.

Seats Developed

The first step in seat development was

to build samples of the desired design to determine any possible fabrication problems. A seat frame and spring assembly of the convoluted wire type was built to develop the base padding for the thickness and feel required by Oldsmobile. The pad was made by hand sculpturing foam rubber to the predetermined contours. The pad then was secured to the spring frame and covered with white muslin. The design lines from the approved quarter scale drawings were duplicated on the white muslin cover to develop master patterns. Detailed patterns, welts, and design padding layouts then were developed from the master patterns.

After completion of preliminary pattern and design layouts, a trim cover assembly was cut and sewed for evaluation of sewing conditions. The trim cover assembly and base pad were assembled to the spring and frame assembly and evaluated for appearance. The seat then was placed in the trim buck for further evaluation with the overall trim combination.

Interior Trim Completed

When the interior trim design was approved, the detail patterns of the various parts then were segregated into groups according to color and type of material. Each group was nested into production stencil and die layouts to determine maximum economy of material usage. Ap-

proved die layouts were released to Production Engineering to begin work on building die cutters. The stencil and detailed material usage information was released to Fisher Body trim fabrication plants.

This completed the Trim Engineering Department's engineering responsibility in regard to the Toronado body. As a final check, however, the completed version of all interior trim components would be again evaluated in test bodies and pilot production bodies for possible revisions before the start of final production

Exterior and Interior Moldings Developed

The interior and exterior trim moldings were given special attention at Fisher Body and Ternstedt Division, which manufactures and supplies hardware and decorative trim to Fisher Body. This attention started with a review of the moldings on the Toronado clay model at GM Styling. When Styling drawings became available, the molding designs were further analyzed and evaluated by Fisher Body and Ternstedt engineers and cost estimators in terms of practical fabrication as well as any styling changes that should be recommended. There soon followed the clay modeling of the new moldings on wood bucks. Drafting work also proceeded on the moldings and their attaching parts. Concurrent with the

building of production tooling for the moldings was the design of checking fixtures to evaluate production parts.

During this time temporary low volume tools and fixtures were expedited so that actual moldings and attaching parts could be tried out on the hand made prototype bodies. Again, designs were evaluated and recommended changes were incorporated into the production tools being built. This had to be completed several months before the pilot production was scheduled so that production parts could be available for the pilot run.

Toronado Body Program Enters Transition Period

In the early stages of the Toronado body program all efforts were devoted to planning, establishing designs, and creating drawings and models. As progress was made in the preparation for production, tools and fixtures were built. Tryout and testing became the order of the day. Emphasis shifted from theory and engineering drawings to the tangible substance of tool steel and body sheet metal.

Dies Designed, Built, and Tested

The several hundred new dies for the Toronado body required thousands of die design drawings, months of intensive construction effort, and more months of die

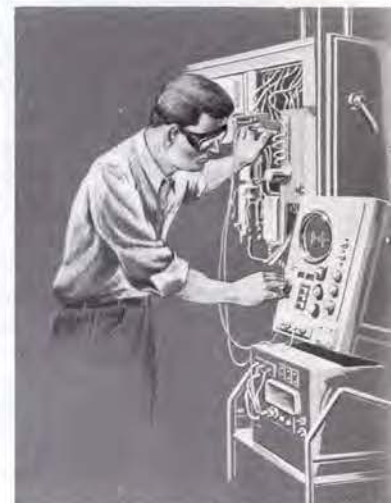
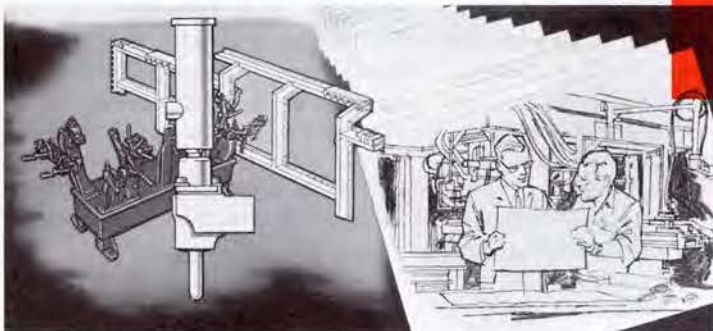

tryout. Several related procedures took place that were an integral part of the overall die tooling program.

Master Gages

Master gages (tools used to coordinate the surfaces of related dies, production tools, and checking fixtures that must be identical) were made early in the die tooling program. Each gage was a three-dimensional representation of a critical body area made to absolute accuracy from a specially prepared drawing. Without the master gages, variations in fit relationship of various parts could have occurred as a result of possible minute differences in part drawings, the interpretation of the drawings, or different construction procedures and workmanship. This was especially important in the fitting of moldings and tail lamps.

Die Model Matching

To obtain a finished appearance for the outer skin parts of the Toronado body, all joining surfaces had to fit perfectly. The method used to achieve this accuracy of part-weld surfaces is known as *model matching*. By means of plastic take-offs, all joining surfaces were coordinated for weld conditions. The plas-

tic take-offs were further used to check fixture construction. By assuring that the master die models matched one another, a major step was taken in the direction of assured quality.

Die Model Cube

As soon as wood die models for the outer panels were completed, the models were assembled, or *cubed*, to form the complete body. This took place before dies were contour machined. The cube set-up then was reviewed to recheck body surfaces and to verify panel highlight lines. Approval at this point gave the green light to proceed with actual die construction.

Die Line Up

A succession of die operations normally is required for most body components. In the case of the Toronado rear quarter fender panel, for example, a large sheet of cold rolled steel had to be converted into a dimensionally stable part with adequate surface quality for high luster finish. This had to be accomplished on a semi-automated basis. It was decided that one draw die and several trim and form die operations would be required. In this sequence, the draw die fabricated

the contour shape of the part. Subsequent dies then accounted for such operations as trimming, flanging, and piercing.

The deep eyebrow styling of the rear quarter fender panel presented a challenge to the die designer. This styling required a departure from normal punch and binder design for the draw die. By simulating draw conditions on a plaster draw die binder set-up, it was determined that uncontrollable compressive forces would be introduced into the blank if conventional straight line punch opening design was used. These compressive forces would cause wrinkles, due to excess steel. The wrinkles, once introduced, could not be removed. To prevent introduction of excess metal and to allow the metal to flow freely in all directions from the binder surface, the punch opening line was moved near the periphery of the wheelhouse opening. Also, the binder was lowered and formed into a conical shape to create a binder wrap of the metal blank. This feature reduced the severity of draw and created a more uniform punch-to-sheet metal contact. During actual toggle press operation with a 1,200-ton thrust, the draw die performs in a delayed action. The binder ring closes first to clamp the outer periphery of the

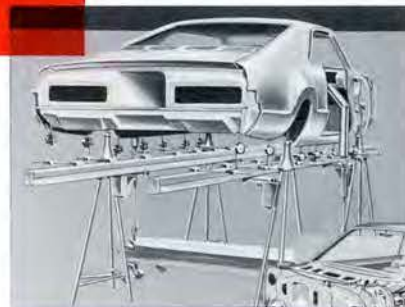

flat blank. Then the punch follows through. In this draw operation a cold flow of metal occurs in the opening provided by the punch-to-die metal clearance.

Die Tryout

Die tryout was one of the most important steps in the transition from the styling concept to the finished body. It was during die tryout that the operational feasibility of a die design was tested and perfected. During the tryout, a thin filament of Prussian blue on the steel blank helped pinpoint where binding occurred. Progressive adjustments led to the final stoning and polishing of die faces. This applied to each successive die in the operational line up. Eventually, acceptable panels emerged and the dies were ready for the pilot production run.

Production Engineering Enters Final Stages

With the completion of preliminary planning and the actual product design under way, the Production Engineering Activity entered a new phase. The emphasis now was on the specific tool design and production planning necessary to accomplish the goal of converting some 4,000 separate parts into the completed Toronado body.

Body Design Presented Processing Challenges

The tool planning program moved into its final stages as advance part prints became available from the Body Engi-

neering Activity. These prints were used by process engineers to determine the tooling and gaging requirements that had to be incorporated into the final design by the product engineers.

For example, the 14 separate panels that make up the underbody assembly were processed to be assembled in three separate sub-assembly feeder production lines that met at an automatic welding station which completed the assembly. Four automatic, two semi-automatic, and twelve manual fixtures were required to provide a balanced production rate and to maintain a sequence of flow through the sub-assembly area.

Assembly Tools Investigated

Process engineers in the Production Engineering Activity released final assembly tool design orders, weld study layouts, and part locating point layouts to the Tool Design Department. The part locating point layouts assured greater accuracy and consistency of manufacture by establishing the coordinated fixture locating points from the fabricating plant through the final assembly operations. The weld studies were made to show the determined method of assembly welding, as well as the quantity and weld spacing requirements.

New Processing Techniques Applied

As tool design progressed, tool engineers were analyzing new techniques and

devices for application in the program. As a result, the mechanized welder used for the underbody had a *walking gun** and spot weld spacing control incorporated into its design. These additions reduced the quantity of mechanical controls, cams, and limit switches required.

A stud welder, which previously had been developed to provide attaching points for windshield and back window reveal molding clips, was given additional use on the Toronado body. The location of an exterior trim molding on the bottom edge of the door made conventional attachment impractical due to interference of the hem flange with the standard attaching clips. This problem was solved by stud welding in which small steel studs were welded to the outer panel with an automatic welder. Heat was developed from the electric arc drawn between the stud and panel. The stud and panel then were brought together with a predetermined pressure when the proper temperature was reached.

Another new processing technique was developed to eliminate a double sealing operation on the rear ventilation plenum chamber drain connection. The rear plenum chamber design of the ventilation system required drain hoses at both sides of the body. Adequate sealing of the connection collars was mandatory to prevent water leaks into the luggage com-

*The walking gun is an indexing welding gun head unit that is driven along a predetermined path or track by either air cylinders or motors. The unit fires at specific intervals.

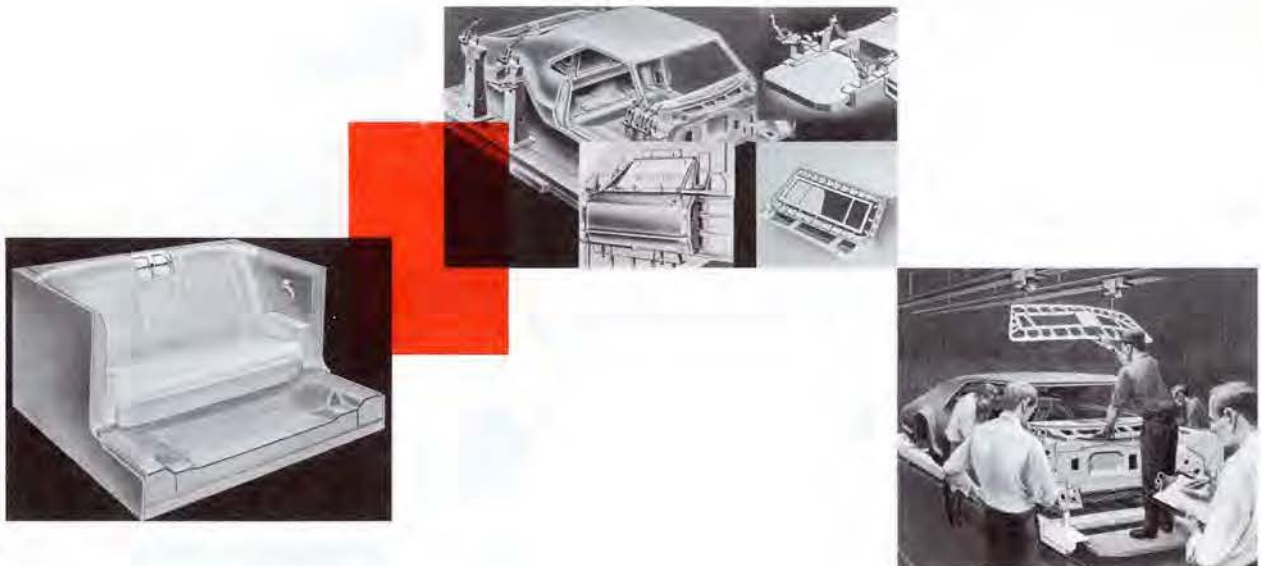

partment. A *wobble welder*[†] was used to apply a seam weld around the collar with an oscillating cam, thus maintaining a continuous weld and eliminating the need for sealers.

Checking Fixtures Developed

Having been advised of construction areas and mating surfaces, the checking fixture engineer proceeded to plan the necessary fixtures and body building aids. Checking fixtures were used to indicate production assembly tooling adjustments required to compensate for metal variations between die runs. This tool adjustment check assured consistency of assembly throughout the production run.

As the design, process, and checking fixture engineers progressed with their work, the body coordination sections were finalized. By consistent use of common locating and clamping points between tools, excessive cumulative tolerance build-up was controlled. Body coordination section (BCS) drawings were prepared by the Body Engineering Activity at the request of the process engineers to assure concurrence of the final body design and the tooling control points. Any product change affecting a clamping point was immediately indicated on the

[†]The wobble welder is a walking roller gun having a cam-controlled erratic motion welding head unit that is designed to maintain a normal weld relocation while turning a tight arc when a vertical plane obstruction is present. A wobble welder also can be considered as a circular electrode welder that uses an erratic cam action to assure only one small arc of the electrode in contact with the workpiece at any one time to attain a complete circular weld.

BCS drawings. This allowed a quick tool coordination.

Soft Trim, Hard Trim Designs Finalized

The steps and procedures required to design and coordinate the tooling for the building of the Toronado body shell does not end the Fisher Body story. Into this shell had to go such items as door hinges, window regulators, glass, seat adjusters, decorative trim moldings, and soft trim requirements to complete the body. These items also required tools and fixtures which came under the design and development responsibility of the Production Engineering Activity.

Dielectric Embossing Used on Interior Trim

Dielectric embossing was used to provide decorative effects on interior trim parts. Although the technical factors involved in each dielectric embossing design may be empirically estimated, considerable testing and development work still was required to arrive at the final production answers. The embossing process was done in a hydraulic press in which the upper half contained the di-

electric unit and embossing electrodes and the lower half contained a movable ram. When the press closed and the dielectric unit was activated, a high frequency wave was generated that caused a molecular reaction in the trim material. The resulting heating of the material and the pressure exerted by the press embossed the pattern design into the electrodes in the surface of the material.

Soft Trim Work Completed

When final soft trim design information became available, the production engineers completed their analysis and determination of the sewing machine, rule cutting press, and critical embossing press work loads. Process engineers then issued design instructions to the tool designers for the cutting blade and embossing plate designs to produce the desired styling patterns. Equipment requirements were calculated from the overall program loads and arrangements were made for the required equipment procurements. All of the trim embossing, cutting, and sewing operations were allocated to Fisher Body trim fabricating plants because of the special skills, equip-

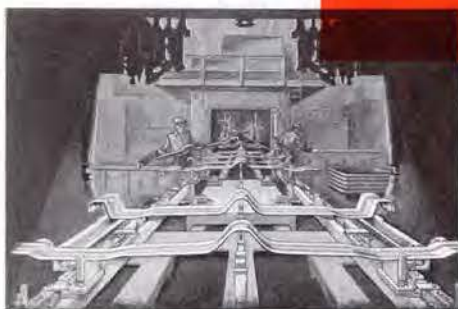

ment, and handling required with the soft trim materials.

Hard Trim Work Completed

Hard trim and hardware parts were next in the process and tool development program.

Over 1,000 assembly plant operation description packages were required for the Toronado program and more than half covered the painting, sealing, trim, and hardware areas. Most of the tooling required in these areas was of the hand tool or light-apply fixture type. The equipment consisted mainly of commercially available portable hand power tools and accessories.

The process engineers involved with trim and hardware had been meeting with the product engineers to obtain design conditions allowing a reasonable installation sequence of parts. Their task was to select the proper power tools to obtain the specified bolt torques, drill the holes, and drive the screws.

The door window glass attachment design consisted of two separate front and rear die-cast lower sash channel assemblies for attaching the bolt-on-glass to the lift mechanism. At each sash channel three flat-headed bolts with large diameter heads bearing on rubber spacers, with a rubber spacer between the glass and sash channel assembly, provided the bearing surfaces for the glass support (Fig. 11). The bolts and spacers were located through holes in the glass. The tightening of the bolts to specified torque requirements with torque-regulated air tools was complicated by the flow factor of the rubber grommets. Specified bolt torques faded and this torque relaxation enabled the glass to shift and thereby lose its sealing fit to the door opening. The problem was overcome by working with the grommet material specifications, material thickness, tooling, and torque specification to achieve a satisfactory bolt holding torque. Fixtures were developed by the process engineers and tool designers that accurately located the sash brackets to the glass. The fixtures were required to provide sufficient adjustment for the allowable cumulative tolerances of the glass, the castings, and the door openings.

Process Planning Nears Completion

Concurrent with the actual tool designs and adaptation of technical improvement

to the Toronado body program was the preparation of operation description (OD) sheets (Fig. 12) by process engineers. These sheets showed in diagrammatic form the part loading and operation sequence of each operation. Operation sequence charts also were prepared to indicate all possible assembly built combinations within certain mandatory load and welding sequence requirements. Each operation then was assigned a number which became the number of the individual operation description sheet. Both the sequence charts and OD sheets were distributed to the assembly plant staff so line operation sequence and manpower work balance could be planned in conjunction with equipment placement.

Pilot Production Program Begins

For much the same reason as a Broadway producer of a play schedules a full dress rehearsal, Fisher Body and Oldsmobile scheduled a pilot production line several months before the start of regular

Toronado body production. The pilot program was a function of the Production Engineering Activity, but it involved other Fisher Body engineering groups as well. The pilot program did not end Production Engineering's responsibility; in fact, it was the beginning of a new phase of concentrated effort. All tools had to be *tuned-in* before the start of production.

One purpose of the pilot line was to enable the plants to provide efficient body production in the desired quantity during the introduction of the Toronado. A number of Toronado bodies were built under simulated production conditions and tools, equipment, and parts were thoroughly evaluated. The pilot line also provided an initial quantity of production type bodies for further tests both in the Fisher Body Laboratories and at the GM Proving Grounds (Fig. 13). The big question that had to be answered during the pilot line program was "how will it build?"

It might be asked: "Why bother with

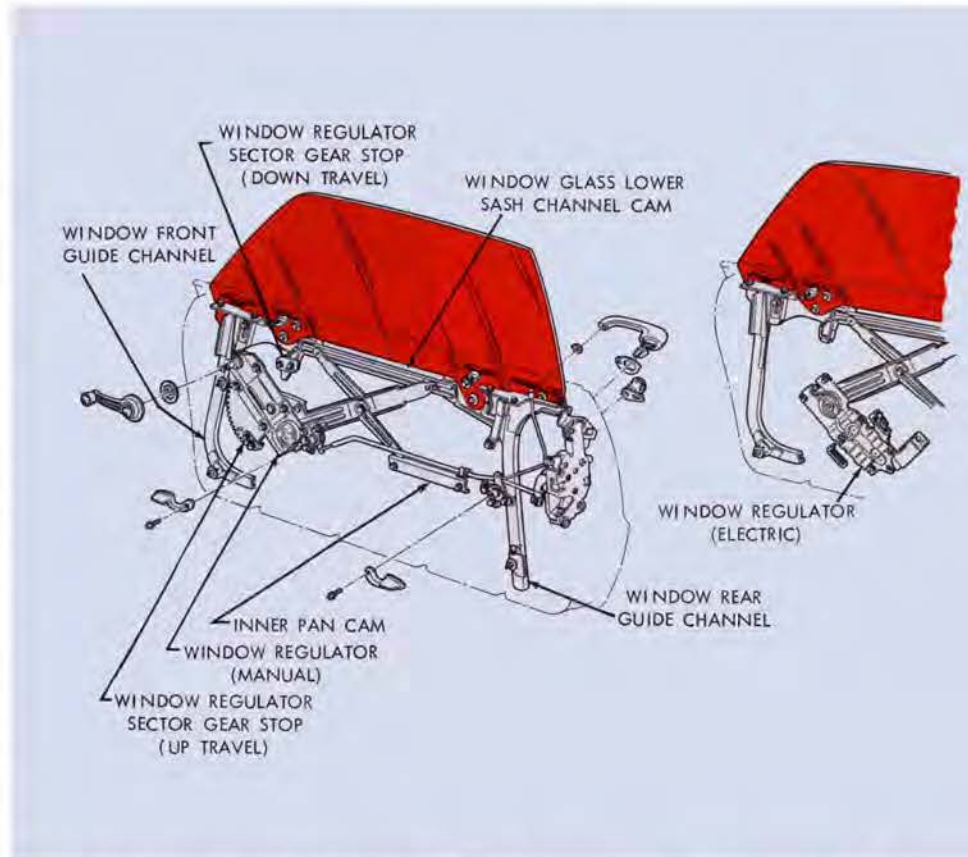

Fig. 11—TORONADO FRONT DOOR HARDWARE. The door window glass is secured to the sash assembly by bolts. To compensate for the changing shape of the glass as it lowered through the door opening, curved window regulator tracks had to be designed.

a pilot run? After all, prototype bodies had been built and tested. If every part was inspected and every operation checked out, then there shouldn't be any problem with production." Experience has shown, however, the value of the assurances gained with the pilot run. Completed Toronado bodies, built exactly like production bodies, were available for further test work months before volume production began. Nothing was taken for granted. Viewed in a different light, the pilot run did not look for glaring mistakes or problems. Rather, the pilot run searched for the little things that might make a big difference.

A typical example of a change to come out of the Toronado pilot program was the addition of two small holes to drain excess Bonderite (a rust preventive solution applied to the entire body prior to painting) from a pocket formed in the dash-to-chassis frame brace. The elimination of the excess Bonderite increased the quality of the final paint finish. In another instance, an existing hole in the wind-

shield upper corner reinforcement was specified as a gage hole to eliminate variance in the metal build-up in this area.

Production Control Planning Vital to Overall Program

Volume production of the Toronado body could not exist without effective production control and the related planning and scheduling required. Consequently, the starting point of production planning and control was the forecast of anticipated volume. The next step was developing a production program to determine the allocation of production to the various fabrication and assembly plants.

After the location of the Toronado body assembly plant was determined, the Production Control Section translated the decision into a definite form of monthly, daily, and hourly capacities. Planning related to "before start of production" included the engineering design and development of the new body, the

dies, fixtures, and production equipment. Also considered were such activities as: the change-over and rearrangement of plant and facilities, the planning of material handling activities, the establishment of production standards, and the arrangement of sources of supply for material.

Of equal importance was the scheduling of production at the assembly plant to coordinate the assembly of finished Toronado bodies with the requirements of Oldsmobile. These requirements take the form of individual body orders (summaries) that specify color, trim, and equipment for each body to be produced. This scheduling phase begins with the pilot run production program and continues throughout the model year.

Final Production Begins

After months of preparation, the Euclid assembly plant was ready to produce the Toronado body. Such materials as steel (1,000 lb would go into each body), glass, fabrics, and paint were moving toward the production line. Fisher Body fabricating plants were sending stamped body parts. Ternstedt Division was shipping the needed decorative trim and hardware parts. All of the 4,000 parts needed for each body were being made available in the right place at the right time.

The day finally arrived when body production began. In general, the sequence of body building follows the pattern of house building. The floor, or underbody, of the Toronado was built first, then the sides were joined, and finally the roof was added. Throughout these operations the same locating and clamping points were used as established by the tool planners. The body shell gained an identity as it passed through the various painting and sealing operations and the hardware and interior trim installations (Fig. 14). When the painted and trimmed body reached the end of the assembly line, the test engineer once more entered the picture. Much of the testing that started during the drawing board stage and that was repeated on hand-made prototype bodies and pilot line bodies now was repeated on the production bodies.

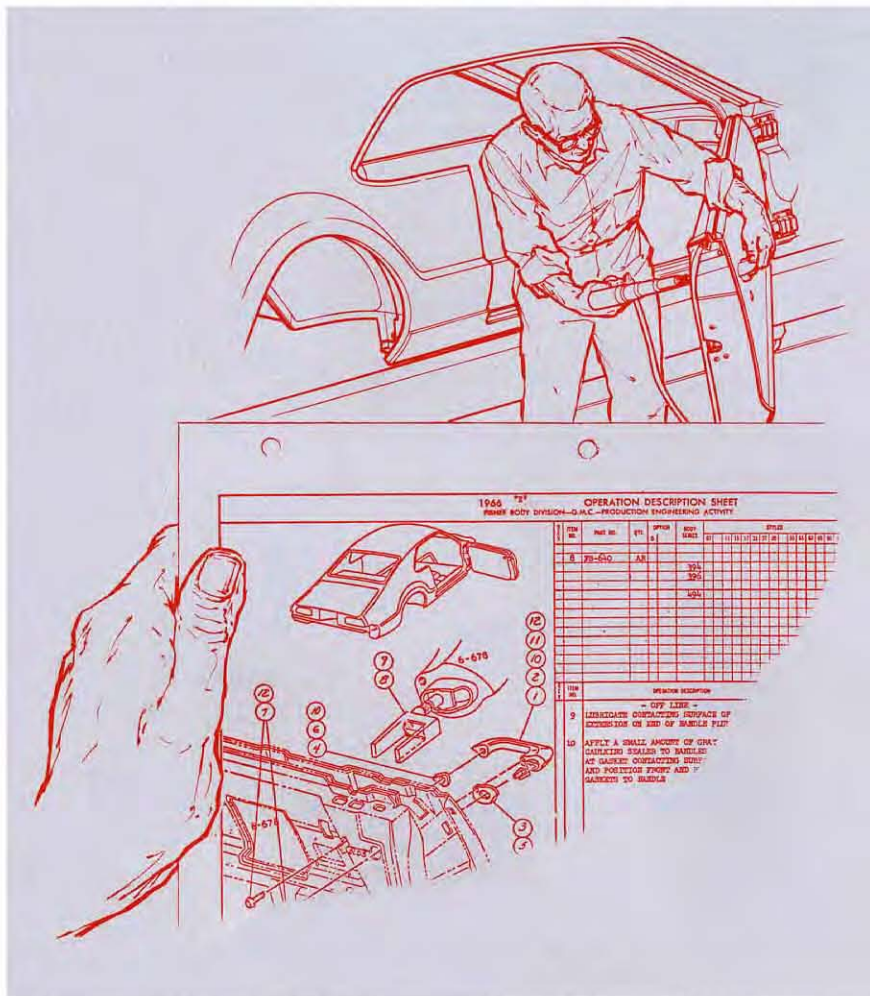

Fig. 12—OPERATION DESCRIPTION SHEET. Process engineers prepared operation description (OD) sheets that indicated the sequence of each line operation. Plant engineers then used the sheets to complete production equipment planning.

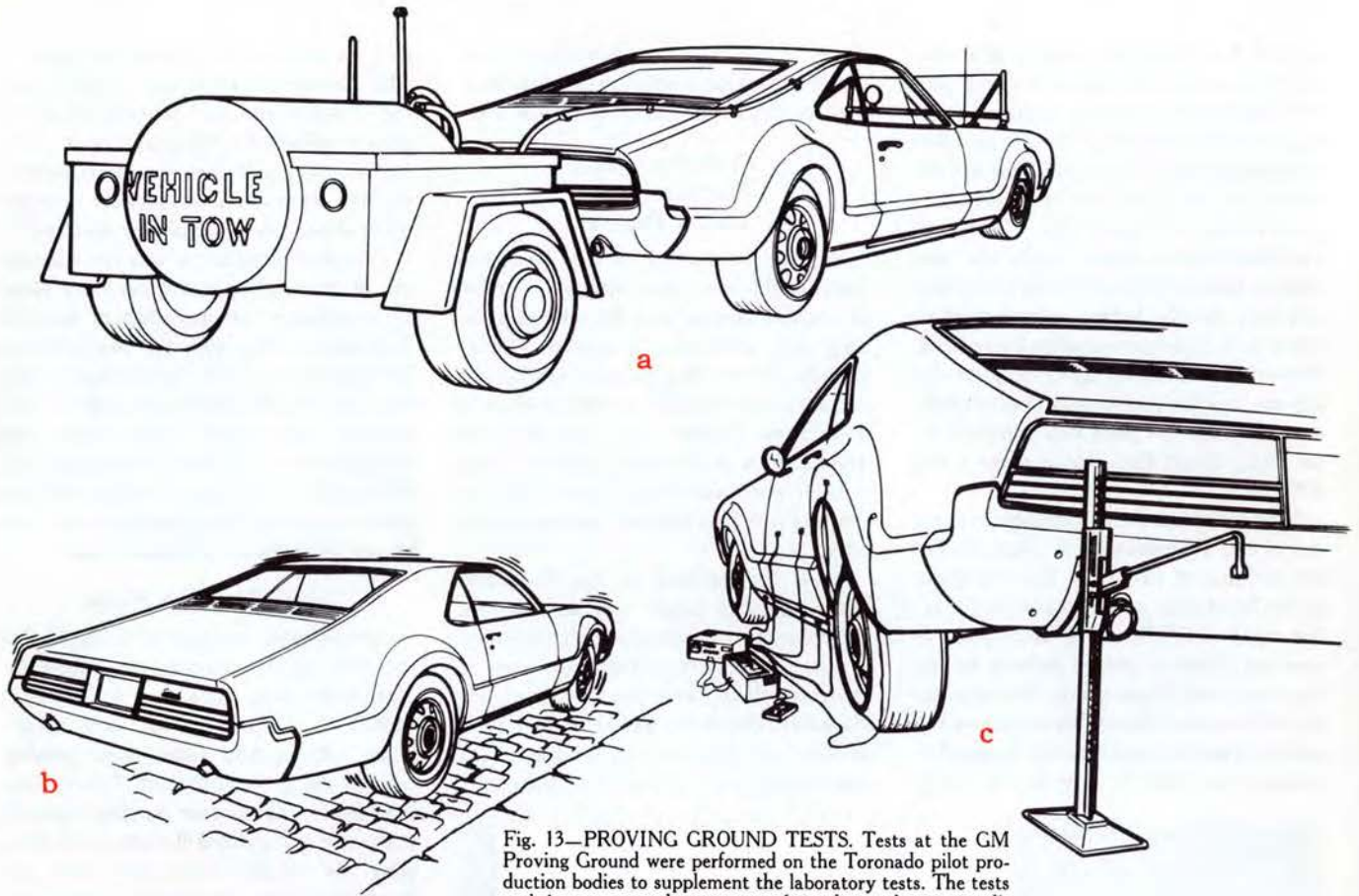

Fig. 13—PROVING GROUND TESTS. Tests at the GM Proving Ground were performed on the Tornado pilot production bodies to supplement the laboratory tests. The tests took into account the extremes of weather and usage conditions. Among the many tests performed were: windshield wiper tests (a), durability tests on the Belgium block road (b), and jacking tests (c).

Fig. 14—BODY ASSEMBLY SEQUENCE. Each Tornado body is erected on a two-ton steel base. The sides of the body are held true to achieve proper fit. Welding guns, grinders, and equipment to lead in body seams are used to fuse the body shell into a solid unit, which then is certified for structural integrity and inspected for complete openings such as windshield, door, and trunk. The body shell gains an identity as it passes through the paint and trim operations. After a final inspection it is ready for shipment to Oldsmobile's final assembly plant.

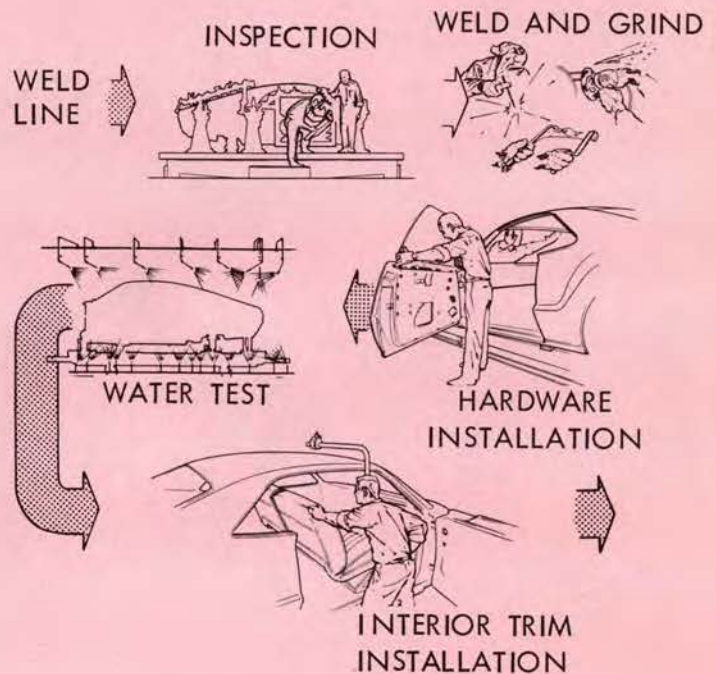



Fig. 15—SHIPMENT OF TORONADO BODIES. Completed Toronado bodies are shown leaving the Fisher Body Euclid, Ohio, plant bound for the Oldsmobile final assembly plant in Lansing, Michigan.

Each assembly line operation performed on the Toronado body was the end result of many factors:

- The process engineer's judgement (could the operation be improved?)
- The type and condition of production equipment
- The quality of individual parts and material
- The high calibre of workmanship
- The demands of Oldsmobile Division
- Fisher Body's pursuit of quality (is there a way to make it better or a better way of making it?).

The Toronado body was only one part of the complete automobile. It still had to be assembled to the chassis components. The start of production at the Euclid plant and the shipment of completed bodies to Oldsmobile (Fig. 15) marked the end of the Fisher Body Toronado story, but began the service life of a new Toronado.

Conclusion

The techniques used to engineer and manufacture an automobile body such as the Toronado have evolved over 60

years of growth and change in the automotive industry. Progress and improvement are the very nature of the business. Customer demand is influenced by changing economic conditions and living habits. Each development opens new vistas of progress. Advances in technology and the availability of new materials and processes provide new areas to challenge the imagination. While new designs that the coming years will bring cannot be foreseen, it is certain that they will be most interesting and challenging to the body builder.

Acknowledgement

The author acknowledges the assistance of Fisher Body engineering personnel whose efforts made this paper possible. Contributions from various engineering Activities and Departments were coordinated by: George R. Lyon, Experimental and Development Department; Jack A. Wallace, Die Engineering Activity; John R. Kari, Production Engineering Activity; Lawrence G. Janisse, Trim Engineering Department; and Joseph M. Scanlon, Trim and Hardware Styling Department.

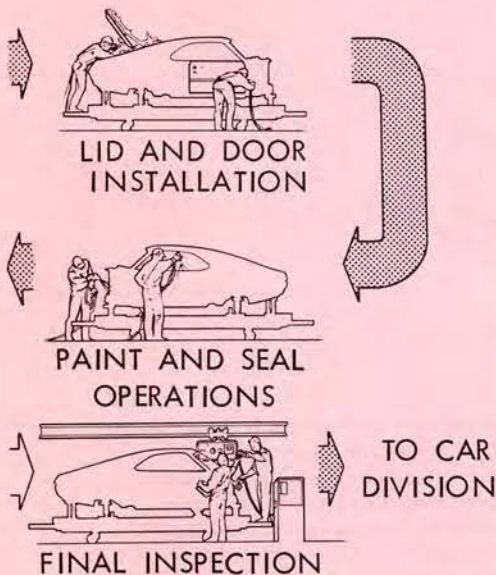

Contributors to First Quarter 1966 Issue of

GENERAL MOTORS ENGINEERING JOURNAL



HARRY F. BARR,

contributor of "Product Engineering in General Motors," is Vice President in charge of the GM Engineering Staff. Mr. Barr attended the University of Missouri before enrolling at the University of Detroit,

which granted him a bachelor's degree in automotive engineering in 1929. Following graduation, he joined GM as a laboratory technician with Cadillac Motor Car Division. He became a project engineer in 1937 then held various engineering assignments with Cadillac, including chief engineer of Cadillac's Cleveland, Ohio, Ordnance Plant. He was made assistant chief engineer of Cadillac in 1950 and two years later was appointed assistant chief engineer of Chevrolet Division in charge of engine and passenger car chassis. He was named chief engineer of Chevrolet in 1956. He assumed his present position in 1963.

Mr. Barr is a member of the National Academy of Engineering, the Society of Automotive Engineers' board of directors, the Engineering Society of Detroit, the American Ordnance Association, Tau Beta Pi, and the Coordinating Research Council. He also is a member of the board of trustees of the Detroit Institute of Technology. In 1965 he received the University of Missouri's honor award for distinguished service in engineering. His work in the field of internal combustion engine design has resulted in the grant of nine patents.



JOHN B. BELTZ,

contributor of "An Overall Look at the Toronado—A New Breed of Automobile," is chief engineer in charge of the Product Engineering Department at Oldsmobile Division.

Mr. Beltz attended the University of Michigan, which granted him the B.S. degree in 1946. He joined Oldsmobile in 1947 as a senior engineering clerk. Prior to joining General Motors, he was employed by the Packard Motor Car Company and the Reo Motor Car Company.

Before assuming his responsibilities as chief engineer in 1964, Mr. Beltz held the positions of project engineer, senior project engineer, experimental engineer, and assistant chief engineer in Oldsmobile's Product Engineering Department.

He is a member of the Society of Automotive Engineers, Engineering Society of Detroit, and the American Ordnance Society. He has had a patent granted as a result of his work in vehicle body design and has published in the field of lubricant testing.



EARL D. BLACK,

contributor of the problem "Determine the Blank Size of a Metal Bracket to Mate Holes of Two Given Parts," and the solution appearing in this issue, is a specialist in graphics and specifications in the

Product Engineering Department at General Motors Institute. He is responsible for developing courses and faculty in engineering graphics.

Mr. Black joined the GMI staff in 1942 as an instructor in the Engineering Drawing Department. He was promoted to section head in 1953 and to instructional specialist in graphics in 1963 before assuming his present position in 1964. Southeast Missouri State College granted Mr. Black the B.S. degree in 1932.

Mr. Black is a member of the Engineering Graphics Division of the Ameri-

can Society for Engineering Education and currently is editor of the *Journal of Engineering Graphics*. He also is a member of the American Society of Tool and Manufacturing Engineers and serves on the Society's Executive Committee and as chairman of its Standards Committee.



LAWRENCE J. KEHOE, JR.,

co-contributor of "Structure and Suspension Development for the Front Wheel Drive Vehicle Concept," is administrative engineer for the Structure and Suspension Development Group, GM Engineering Staff.

Mr. Kehoe joined General Motors in 1927 as a General Motors Institute student in the cooperative engineering program sponsored by Cadillac Motor Car Division. Following graduation from G.M.I. in 1931, he worked with the Special Problems Group of Cadillac's Engineering Department. In 1940 he was transferred to the GM Engineering Staff's Product Study Group, which later became the Structure and Suspension Development Group. He assumed his present position in 1957, after having served as project engineer, senior engineer, and experimental engineer.

Mr. Kehoe, who received the B.I.E. degree from G.M.I. in 1961, is a member of the Society of Automotive Engineers and serves on several S.A.E. technical committees. He has published papers concerning suspensions and chassis lubricants.



JOHN D. MALLOY,

contributor of "The Development of a Unitized Power Package for a Front Wheel Drive Vehicle," is a senior project engineer in the GM Engineering Staff's Transmission Development Group.

Mr. Malloy joined General Motors in 1951 as a junior engineer with the Transmission Development Group. He was